

NORTHROP GRUMMAN

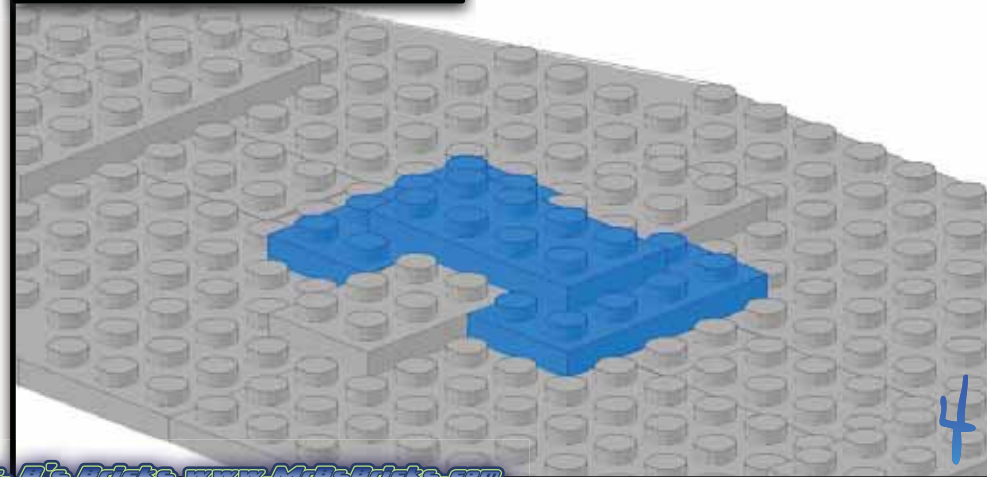

Build Your Own JWST With LEGO® Brand Blocks

Peering deep into space and back into time, the James Webb Space Telescope will improve our understanding of the evolution of the universe

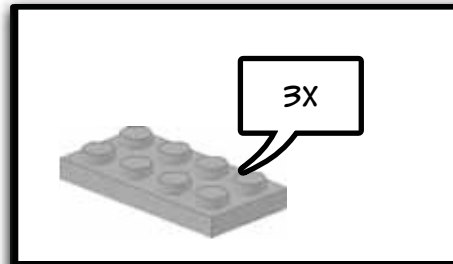
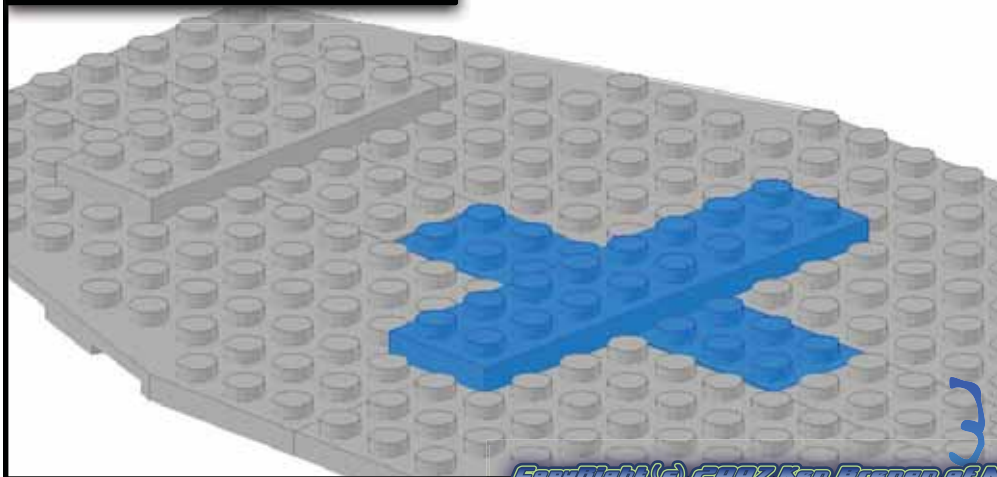
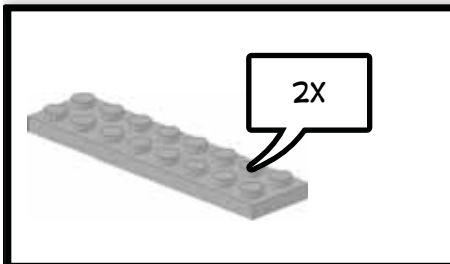
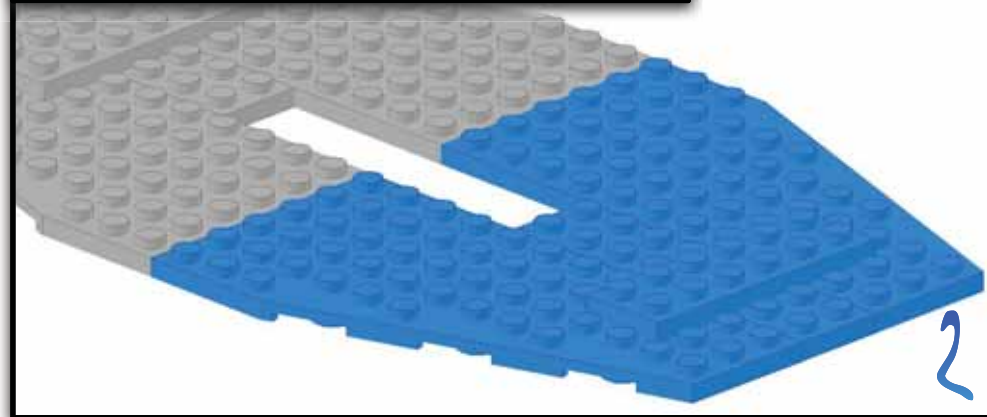
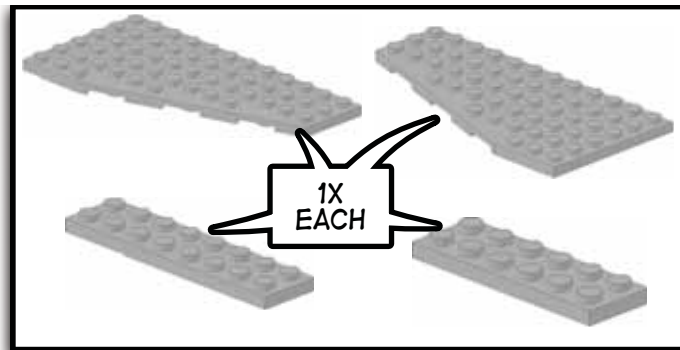
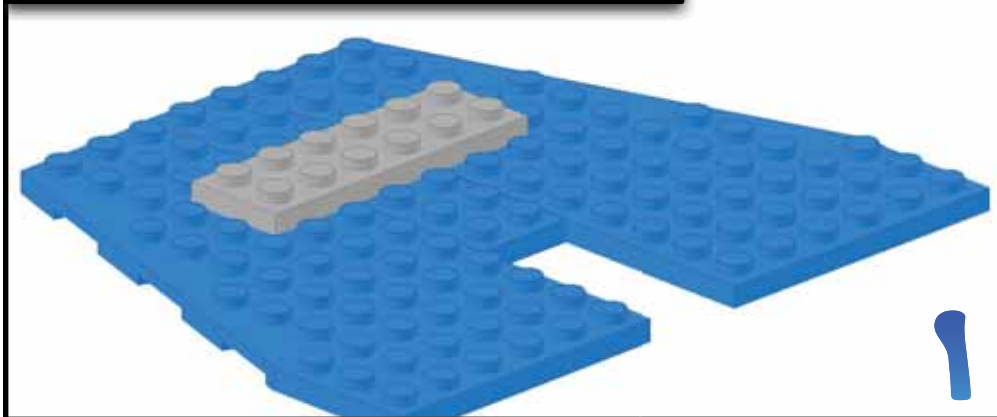
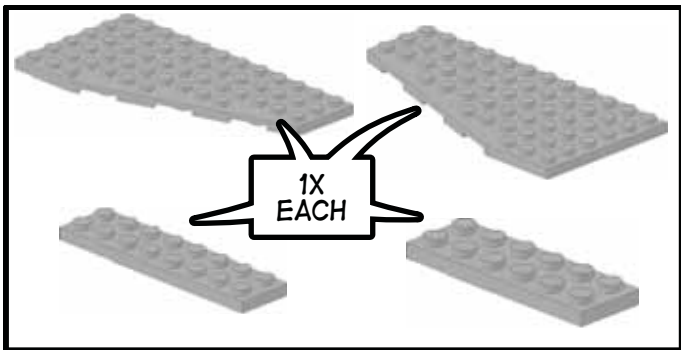

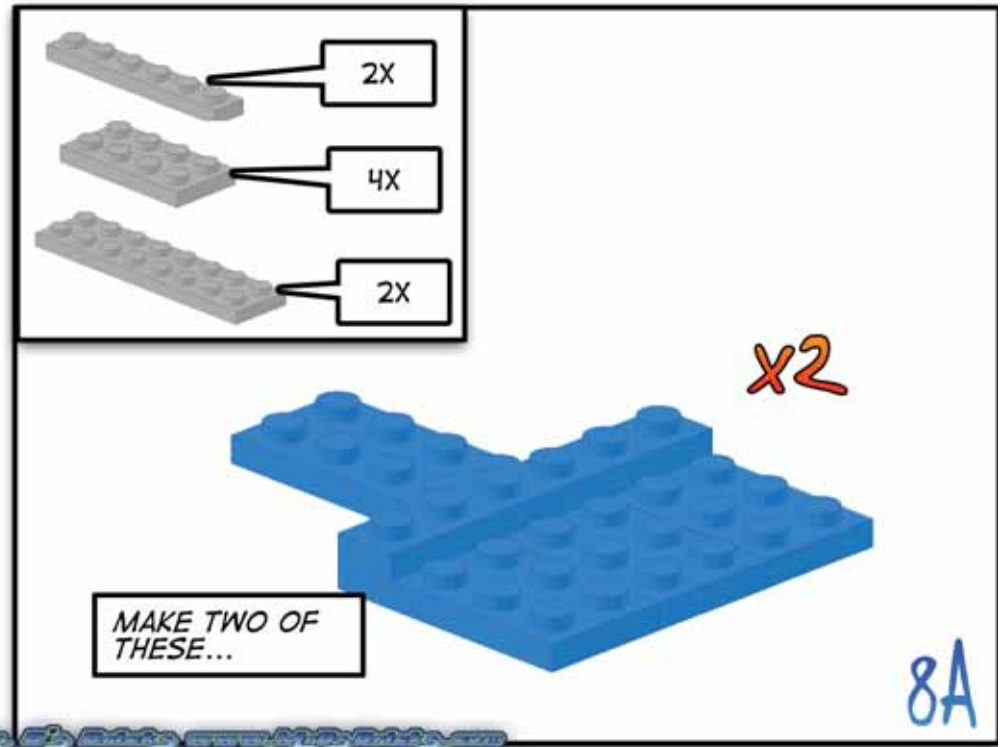
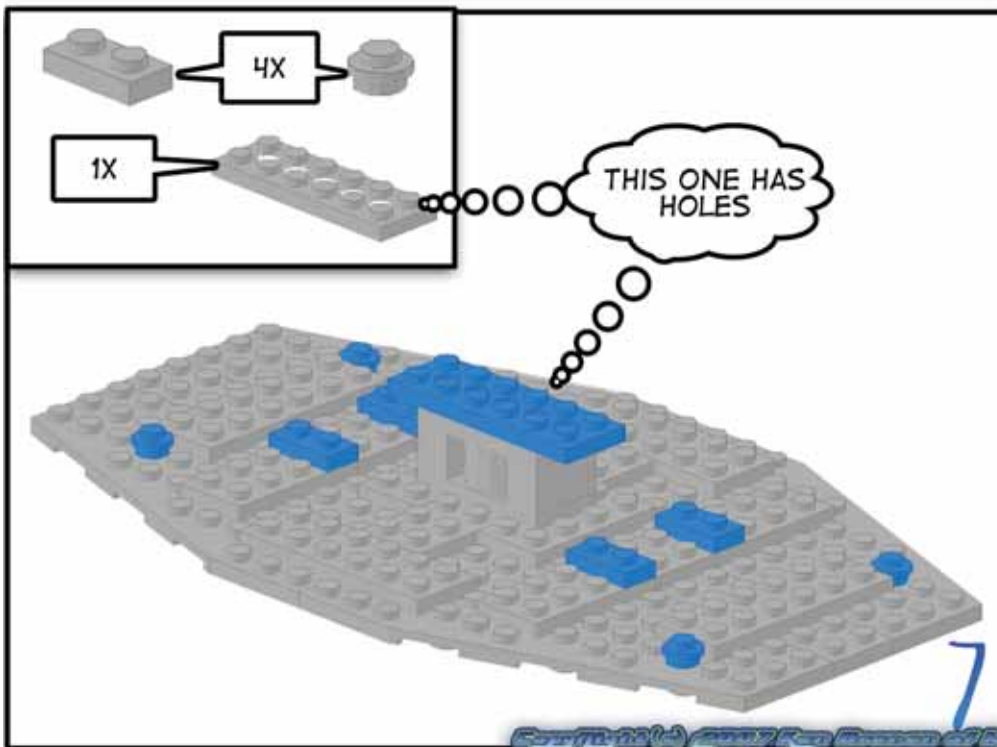
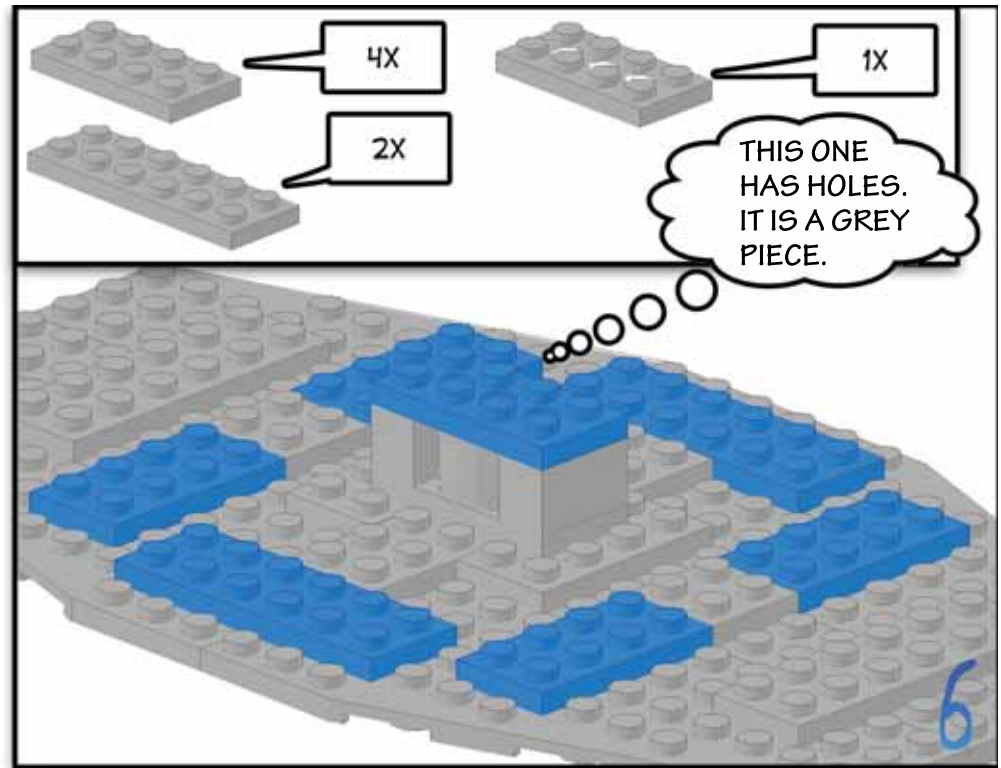
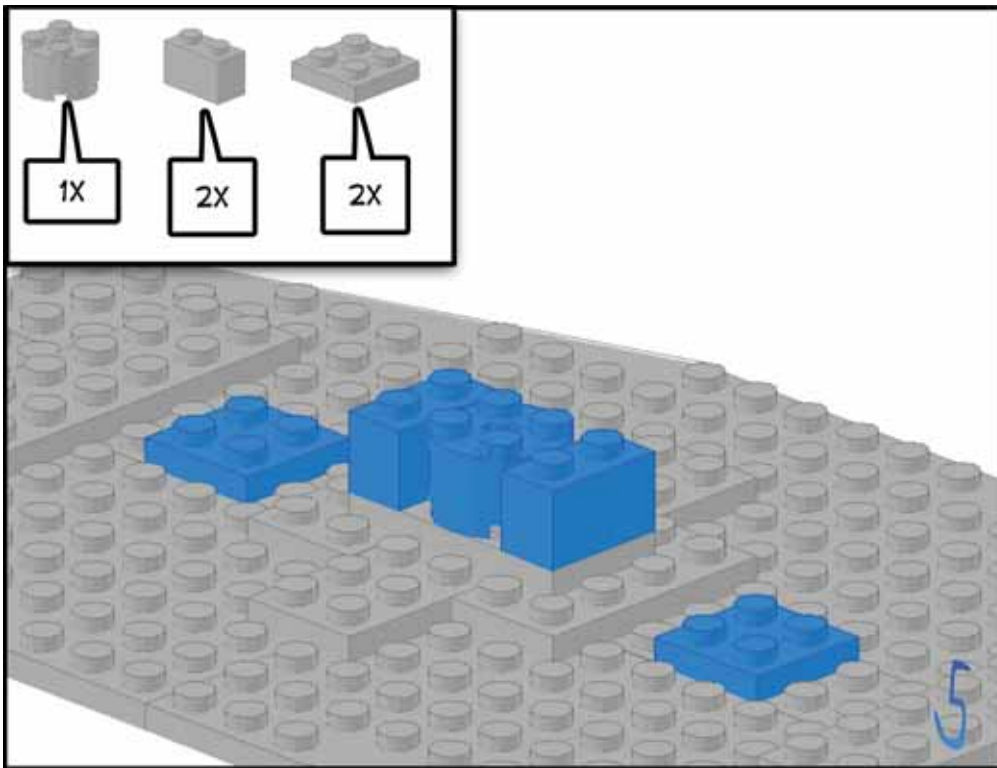

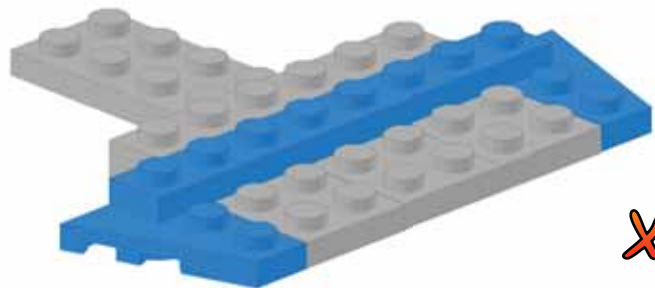
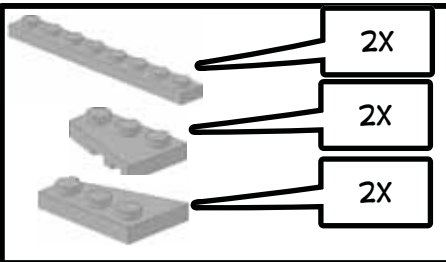

x2

8B

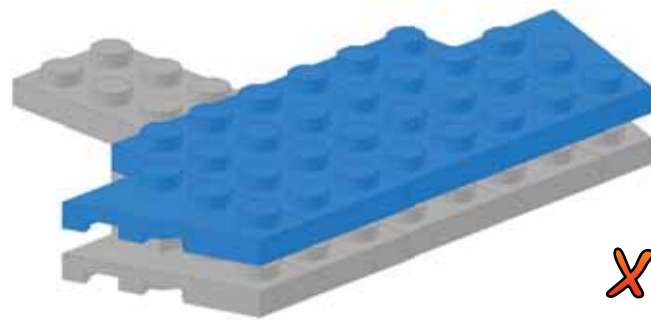
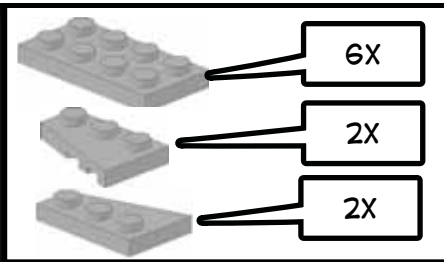

x2

8C

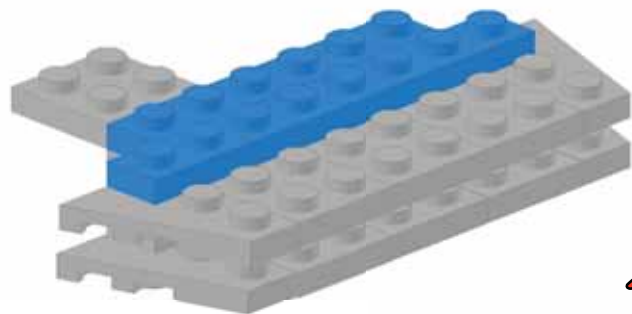
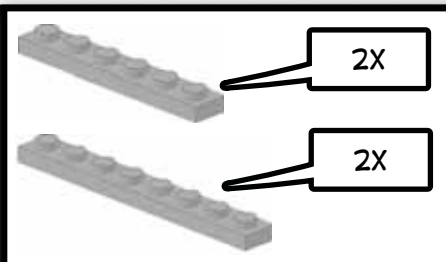

x2

8D

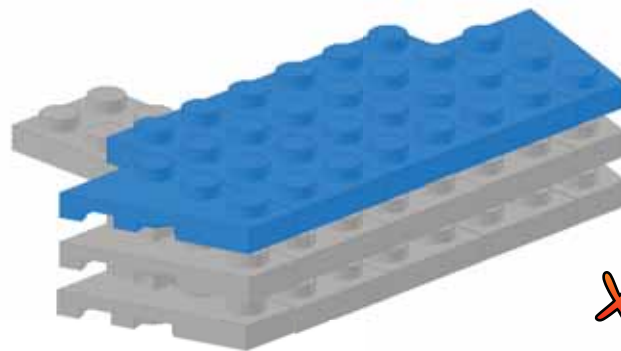
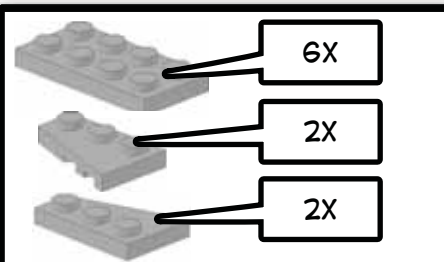

x2

8E

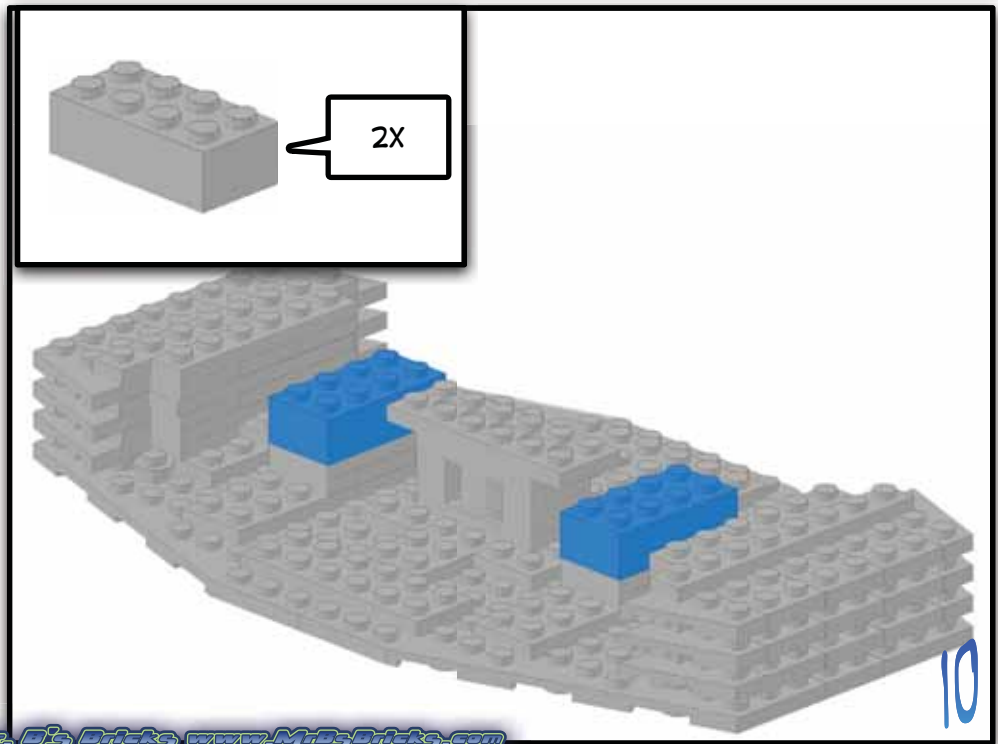
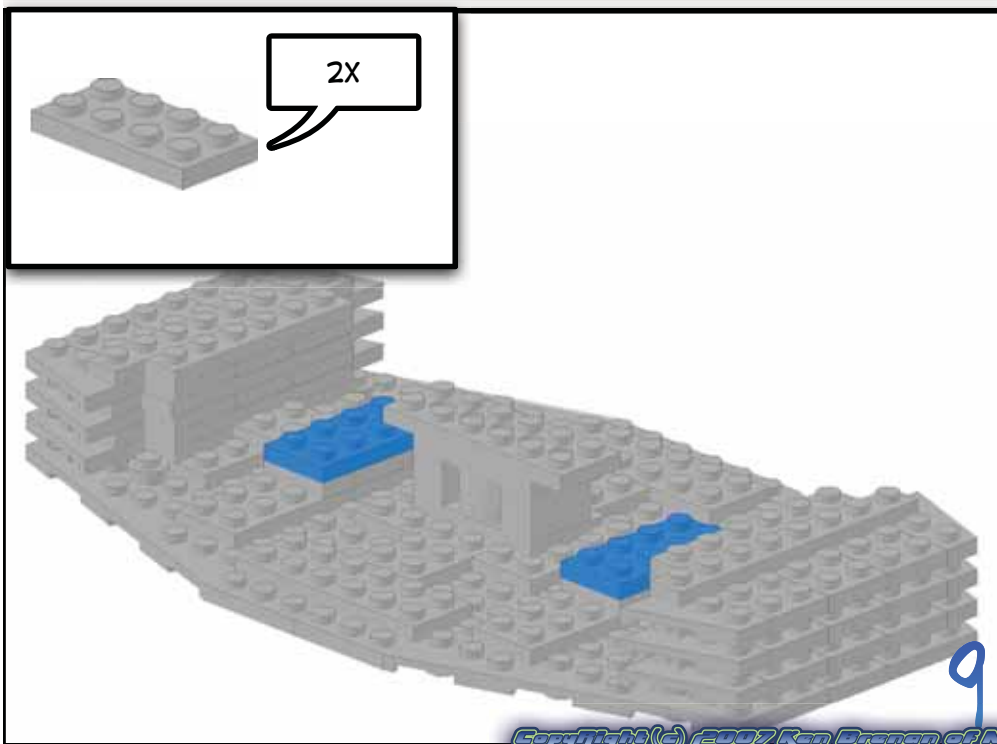
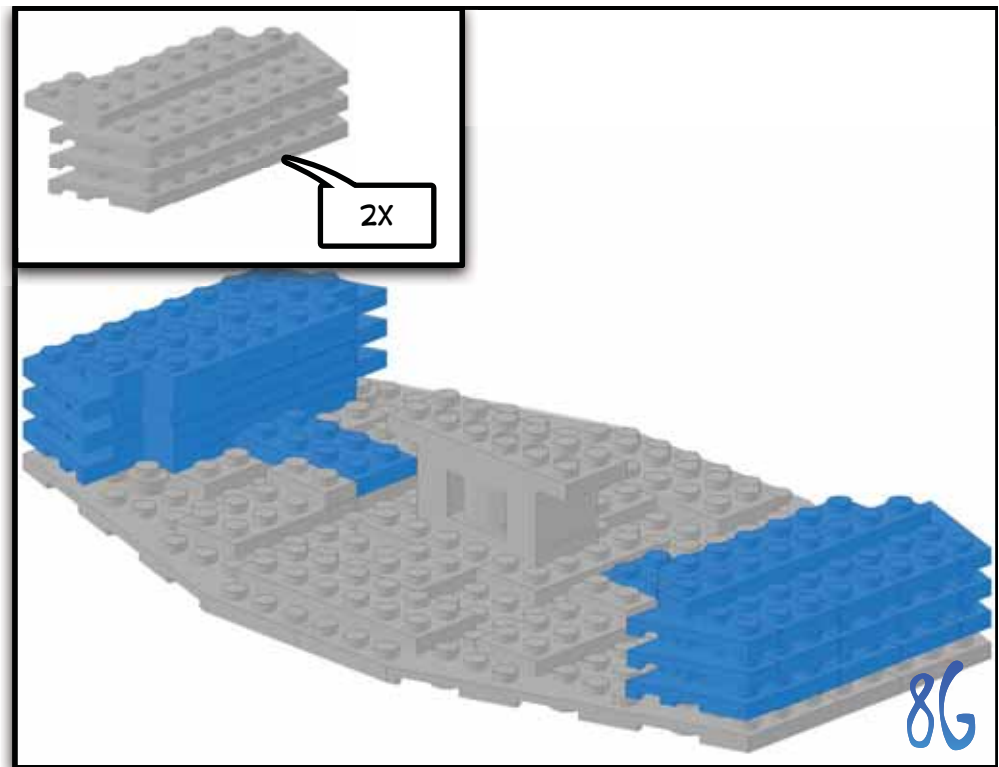
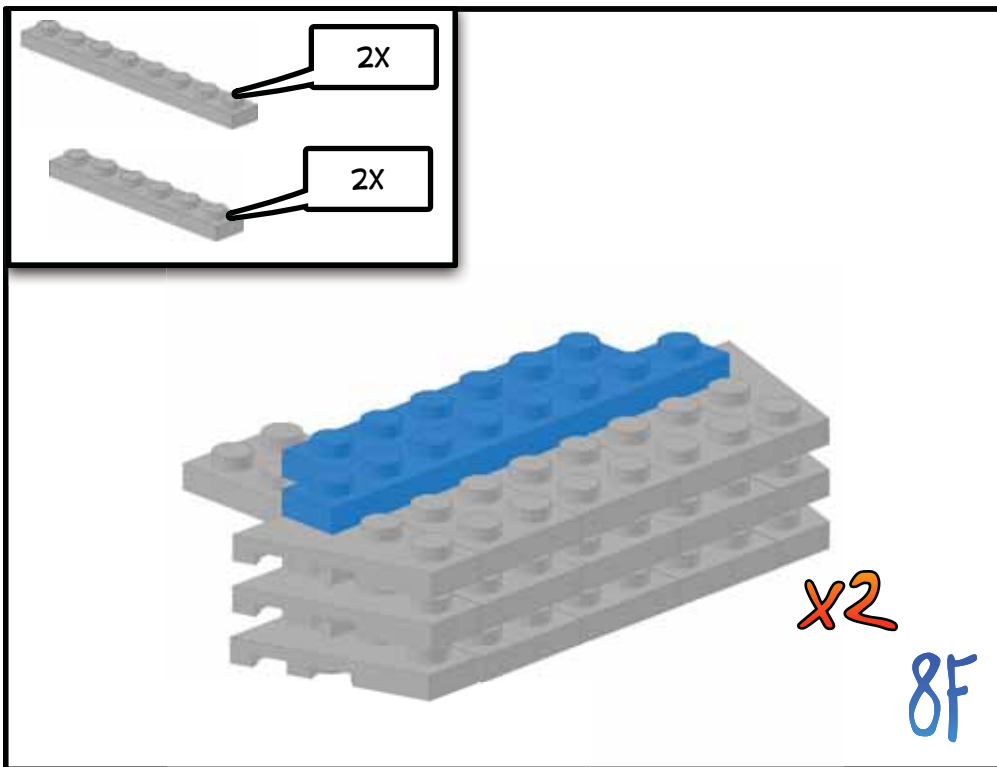

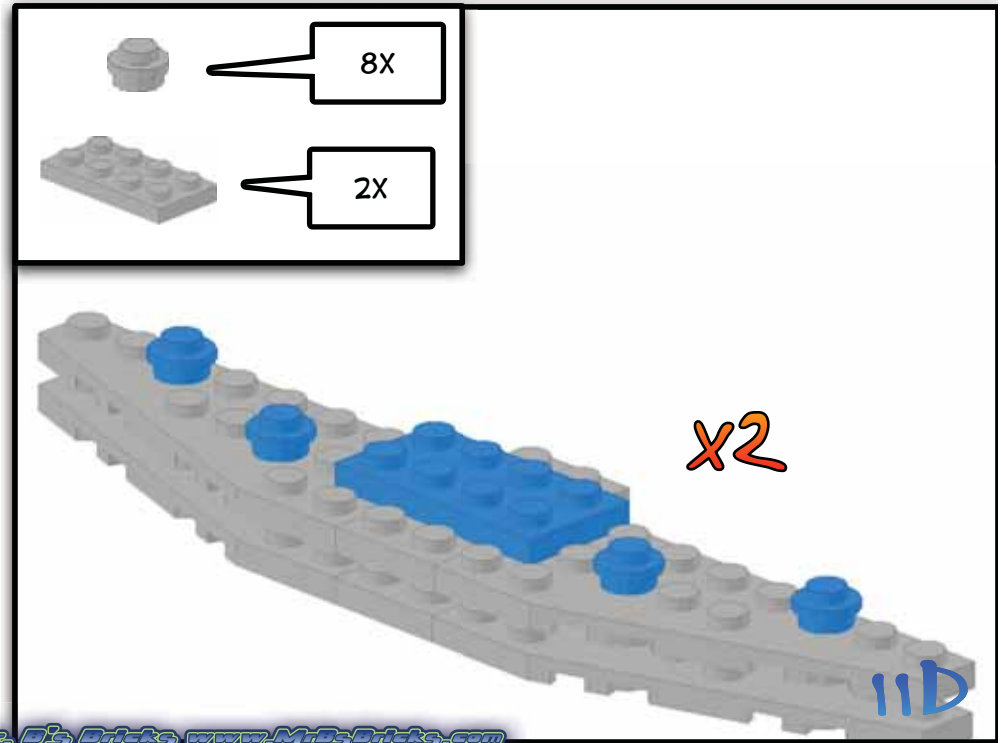
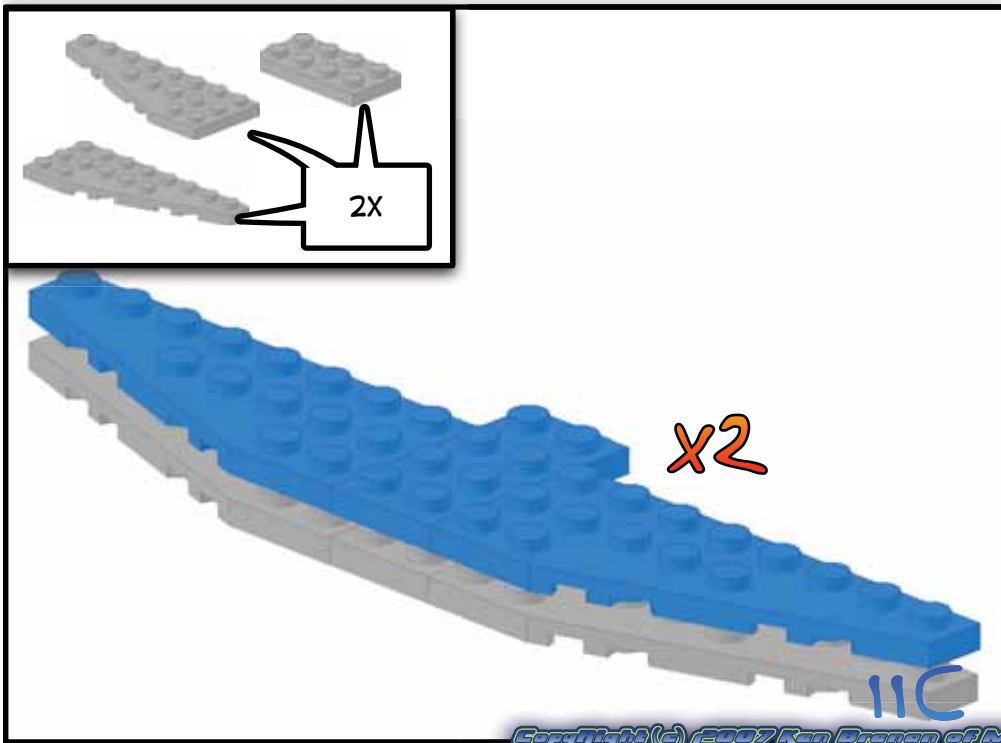
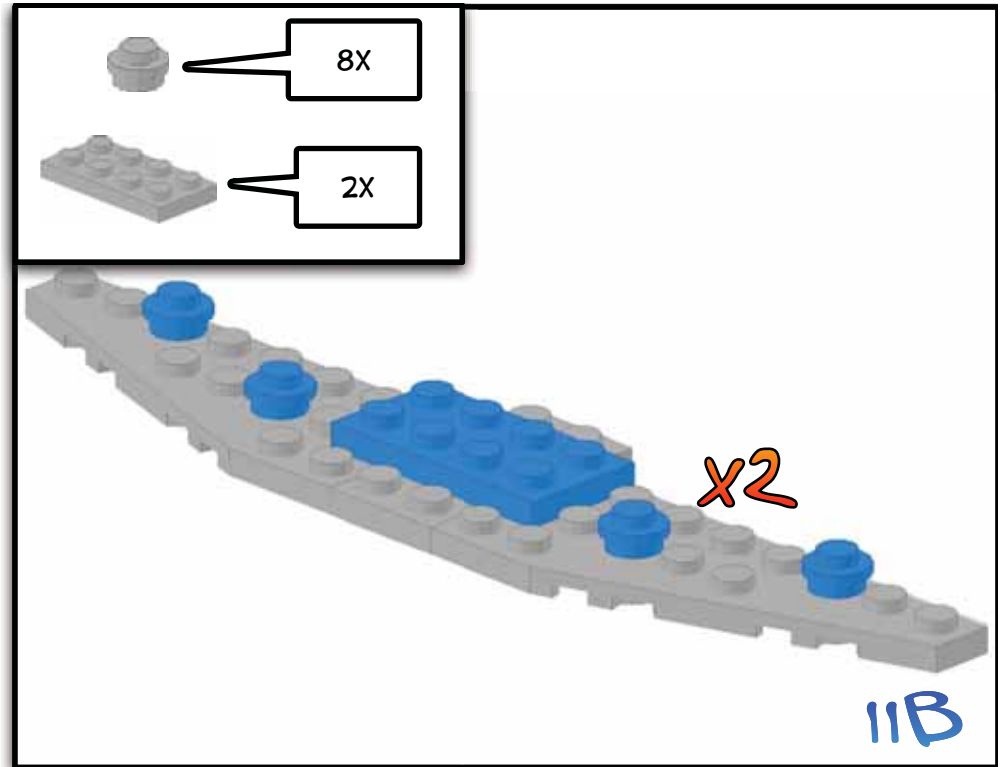
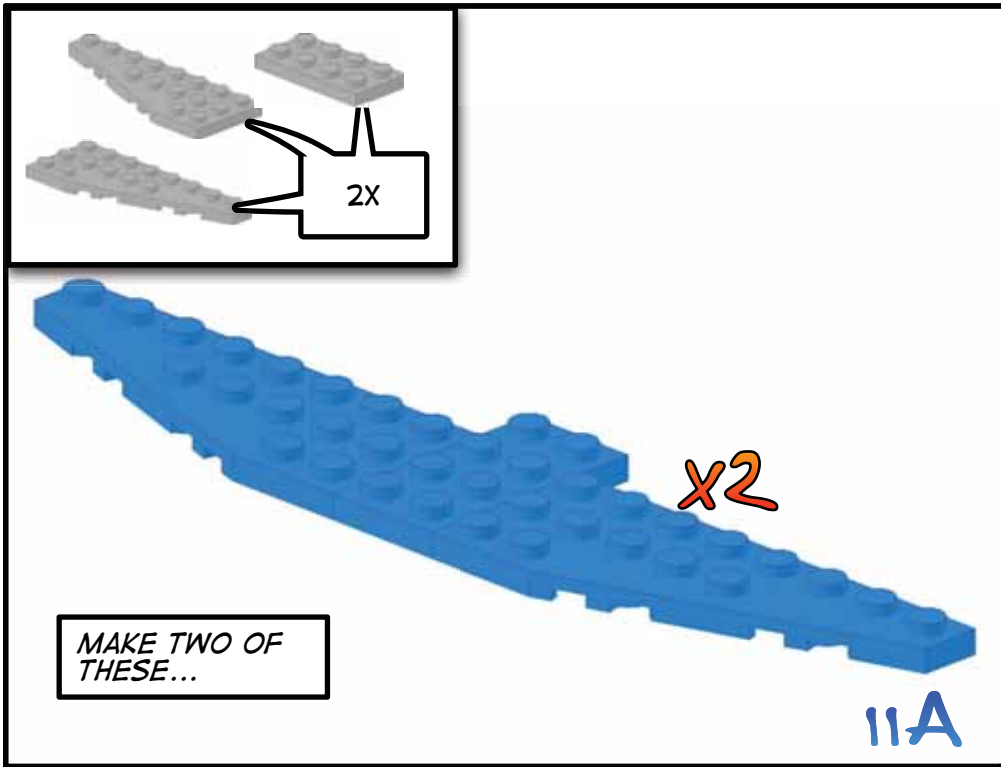

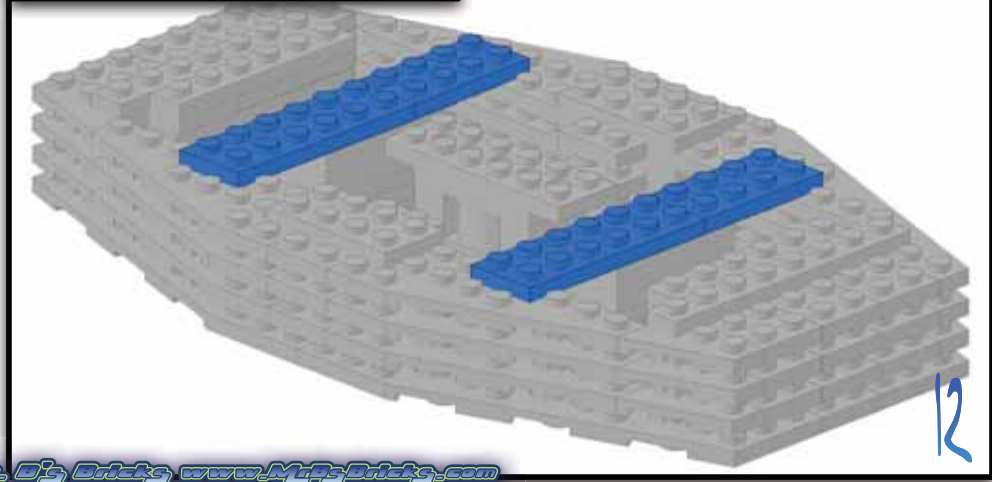
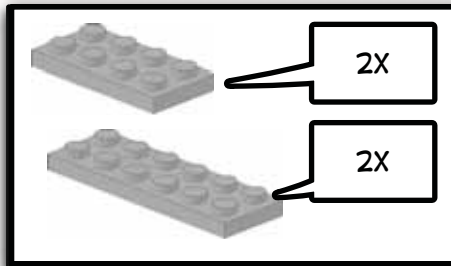
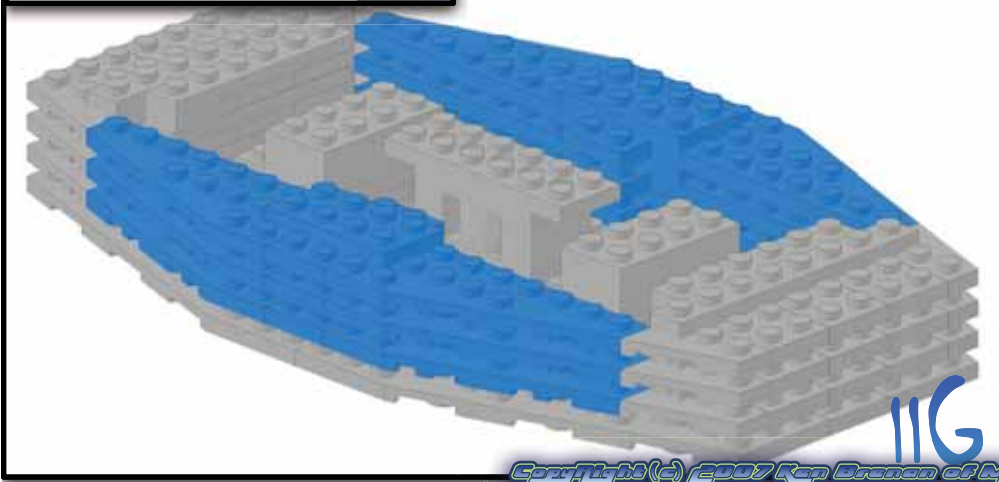
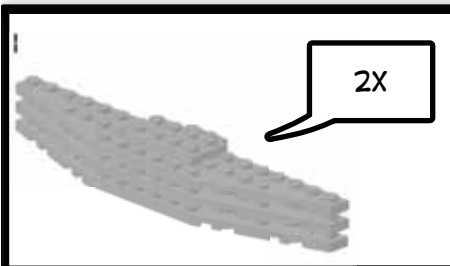
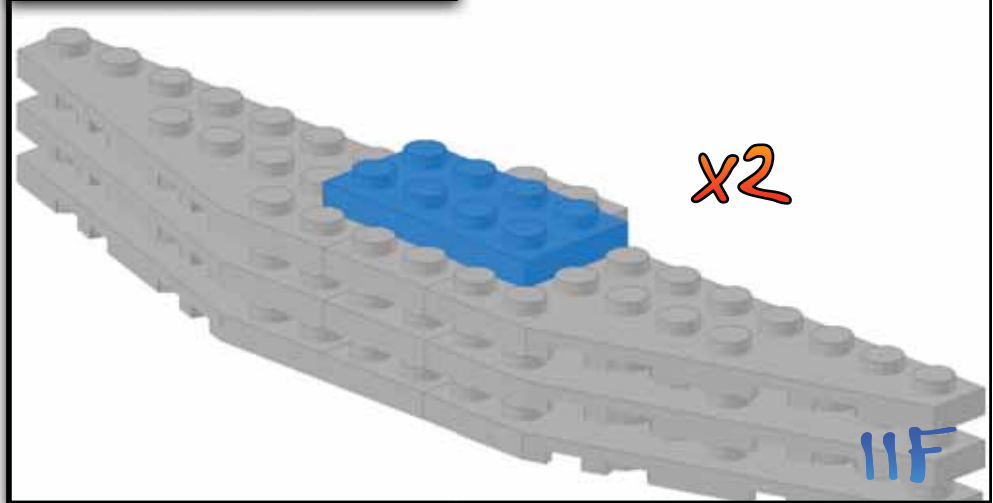
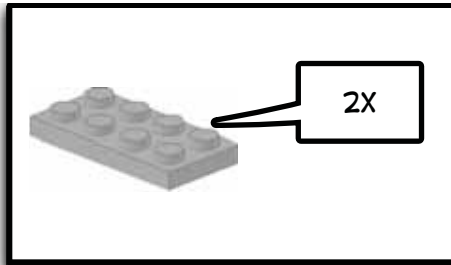
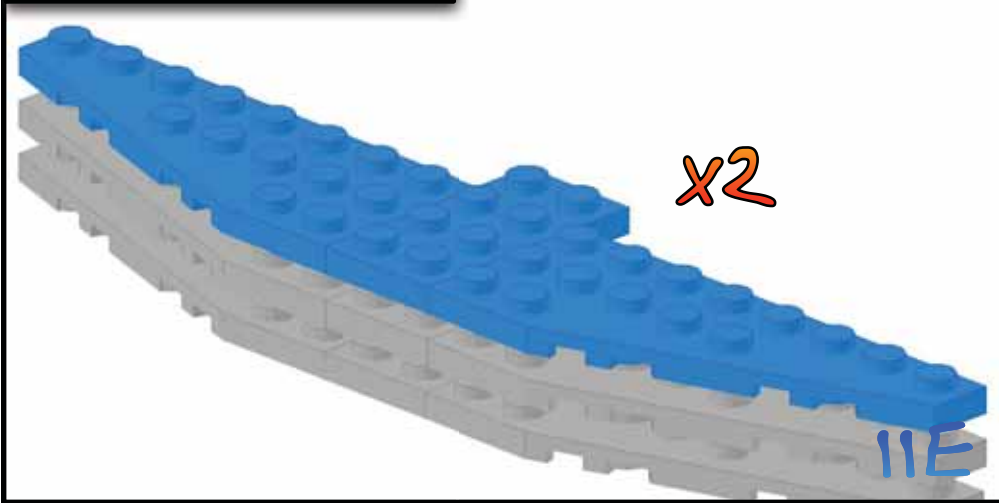
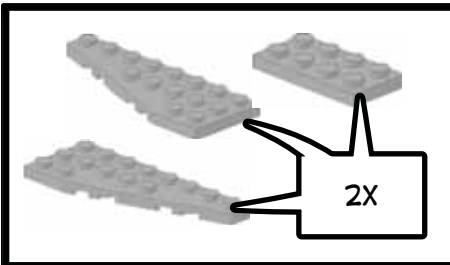

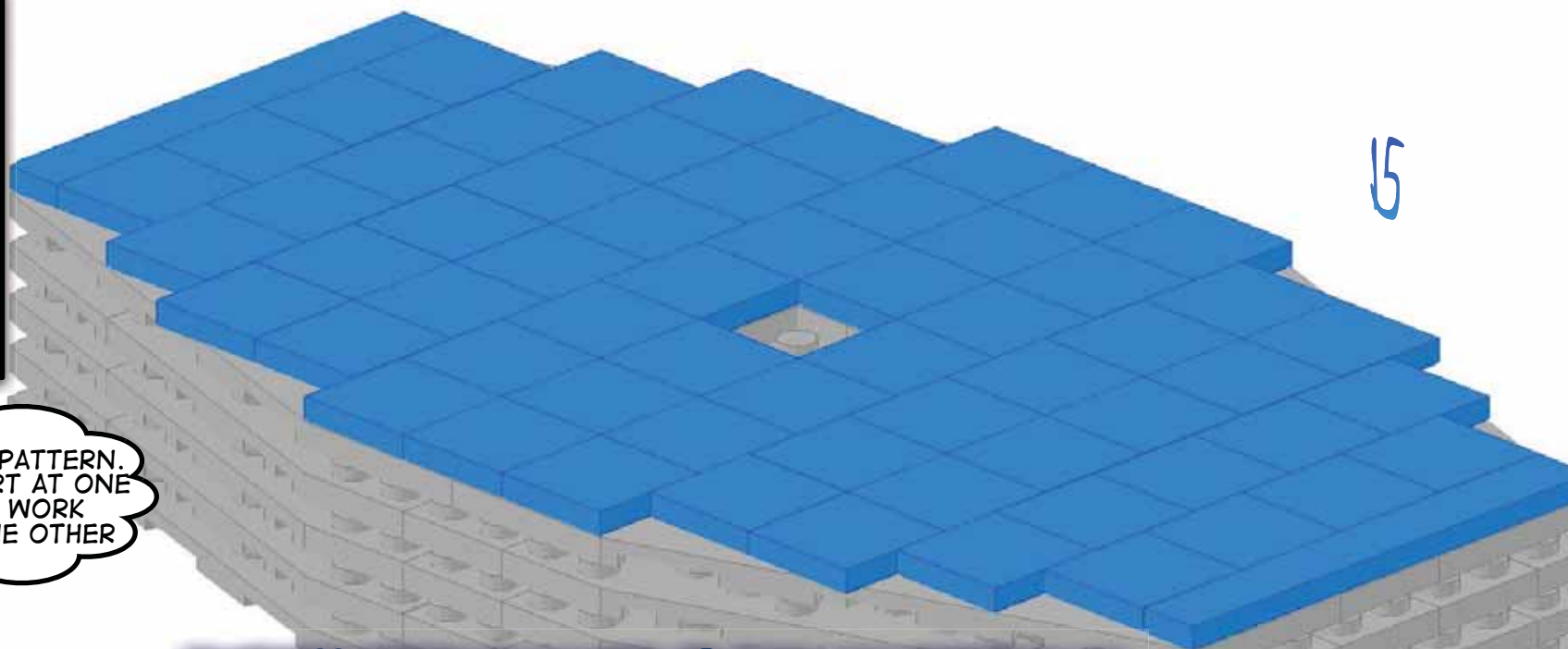
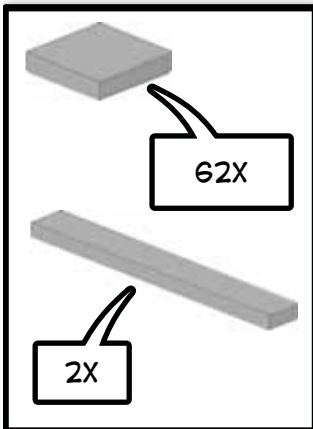
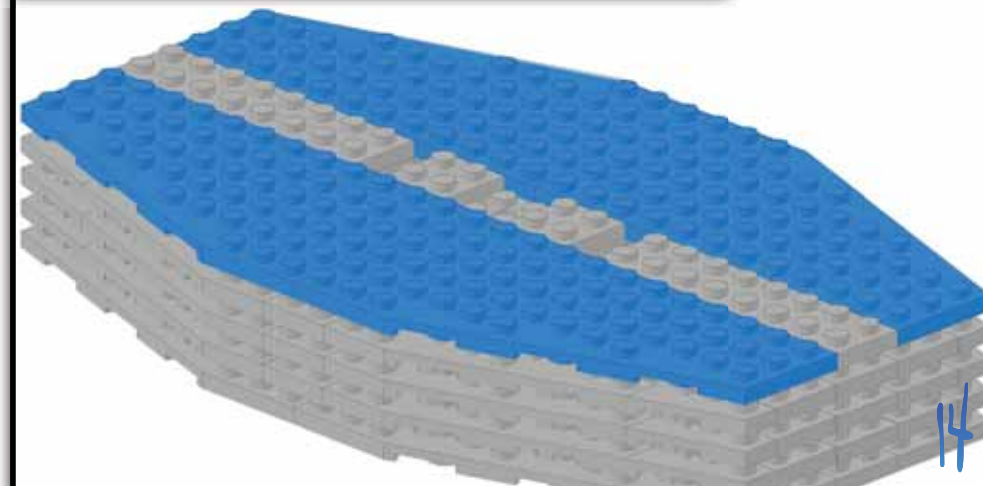
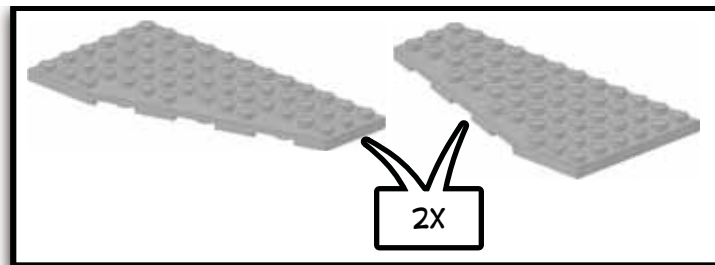
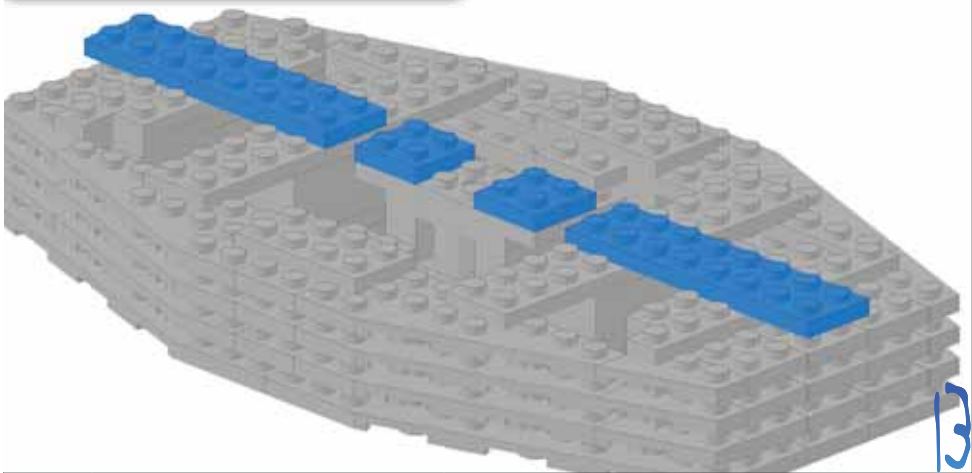
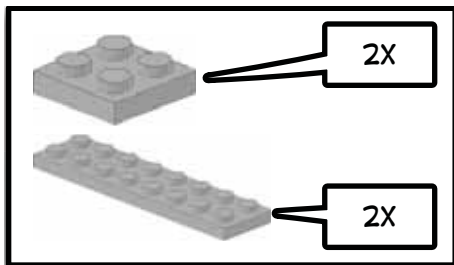

WATCH THE PATTERN.
HINT - START AT ONE
END AND WORK
TOWARD THE OTHER

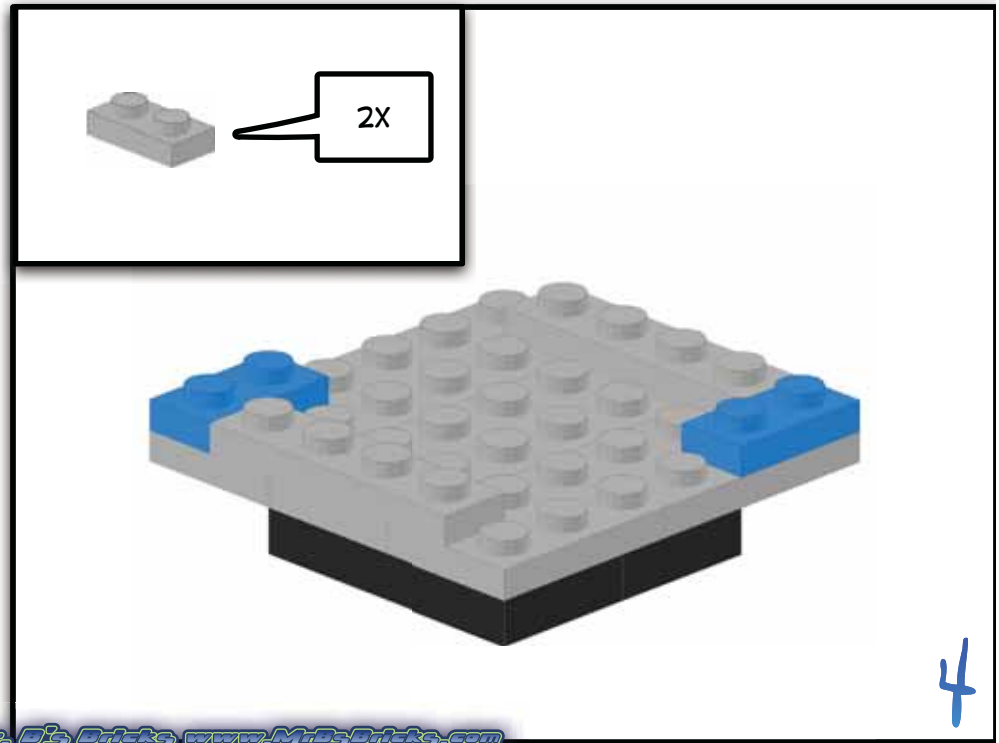
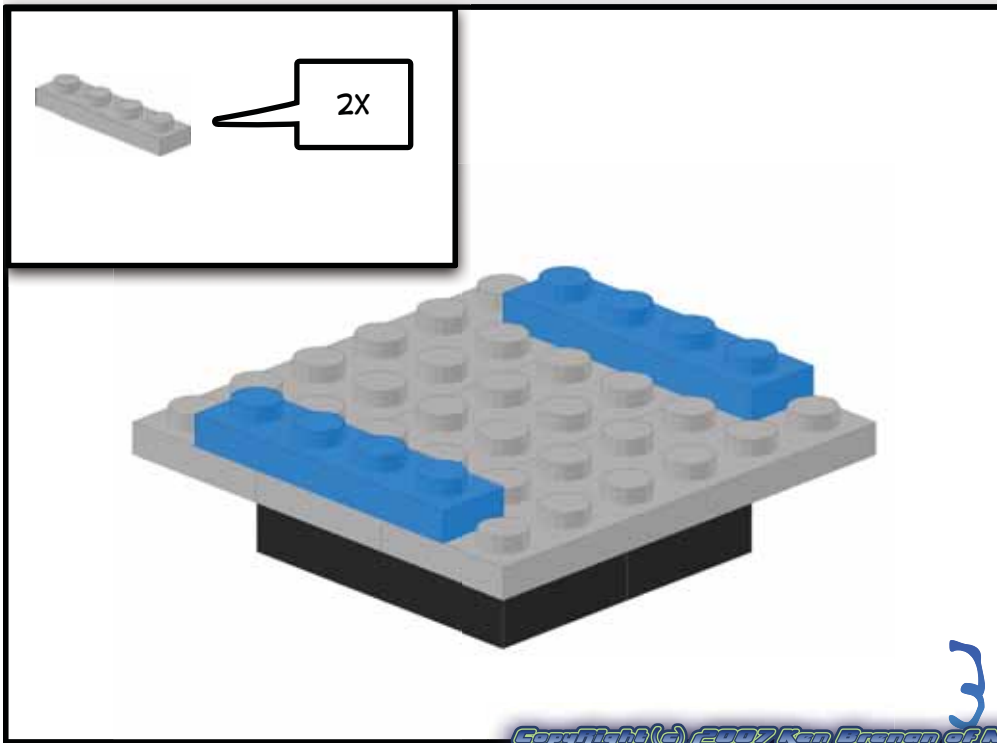
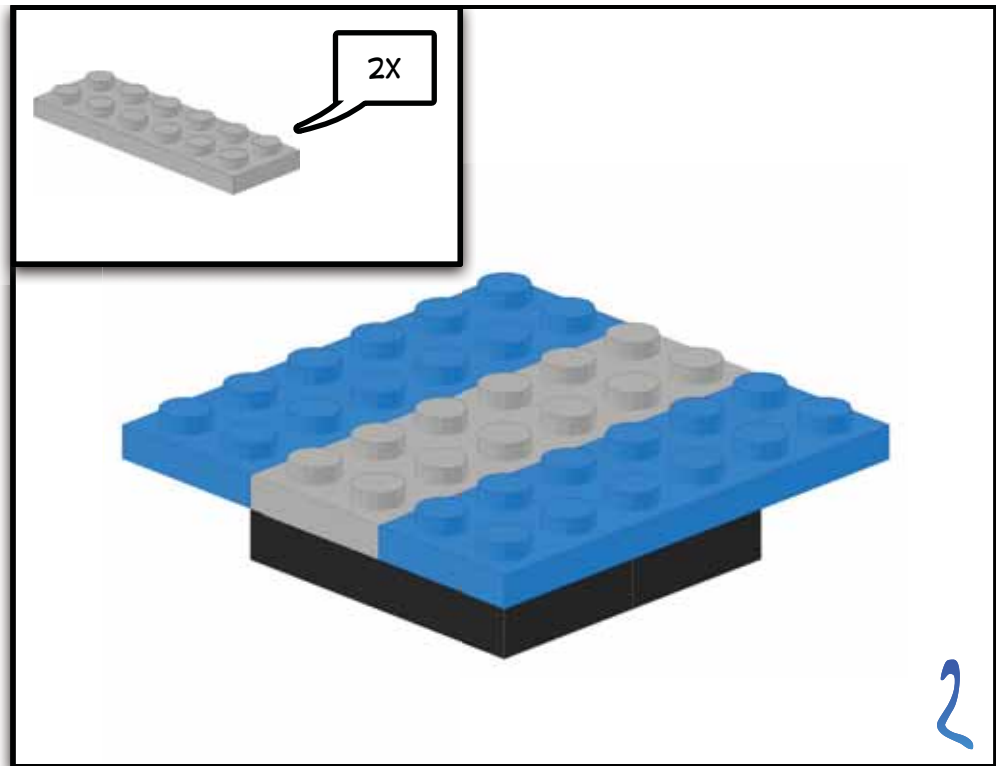
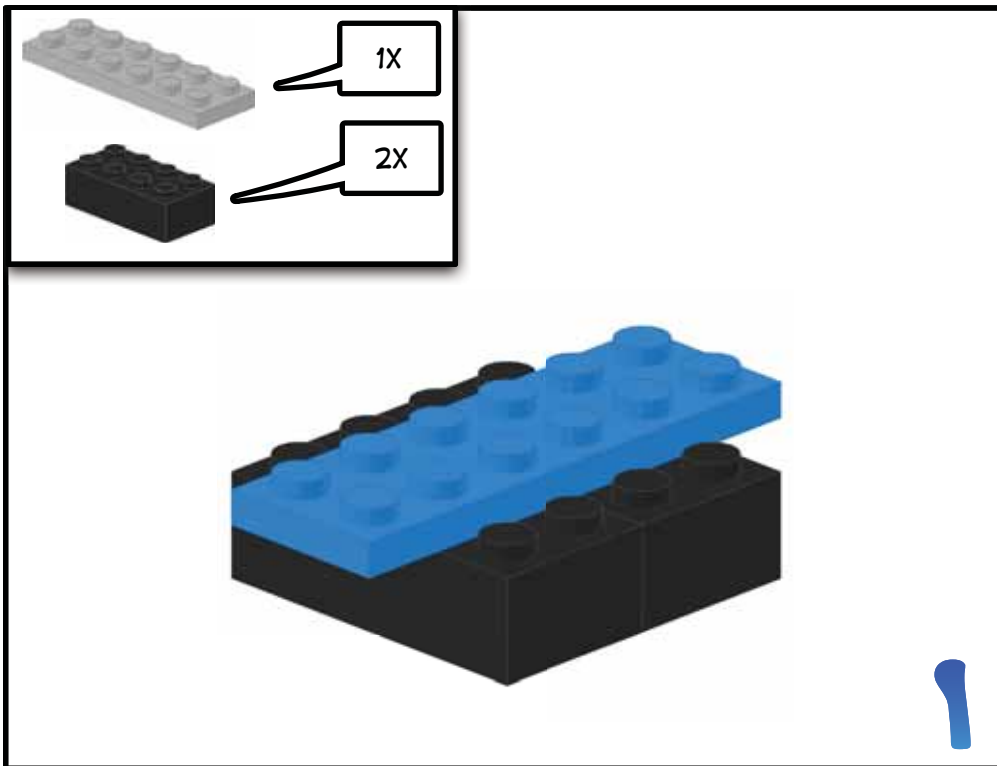

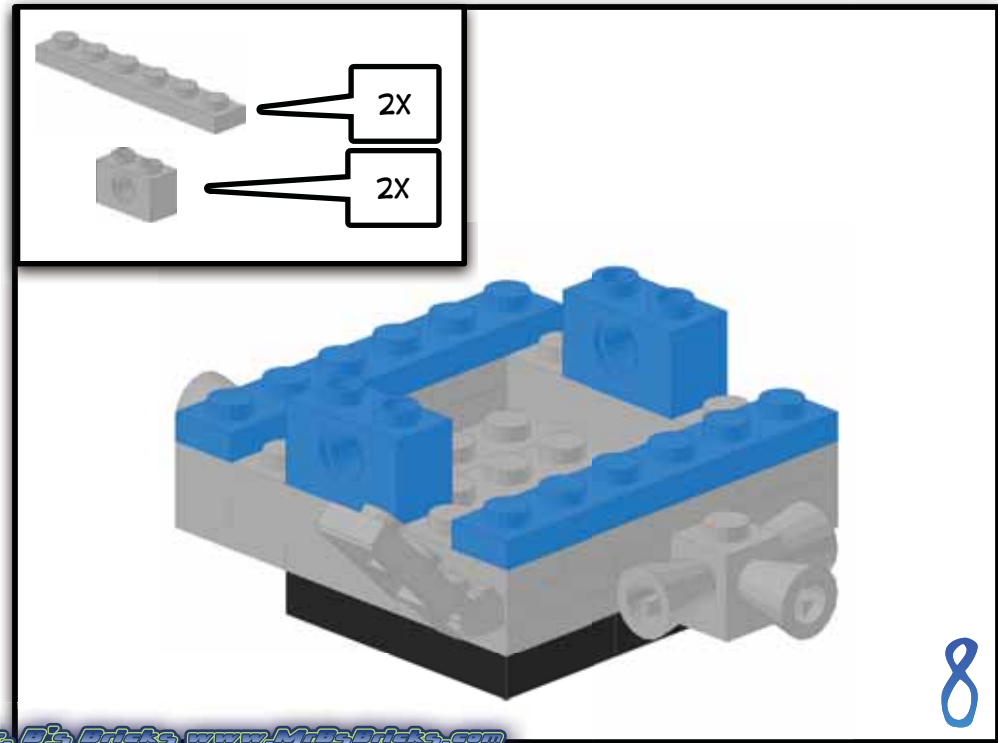
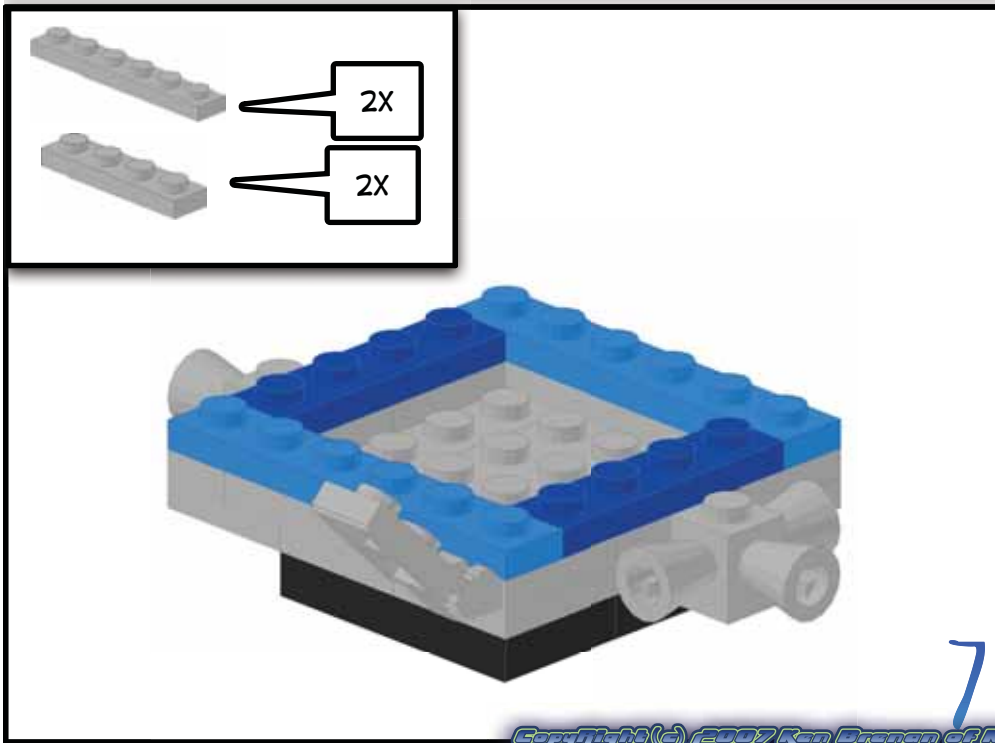
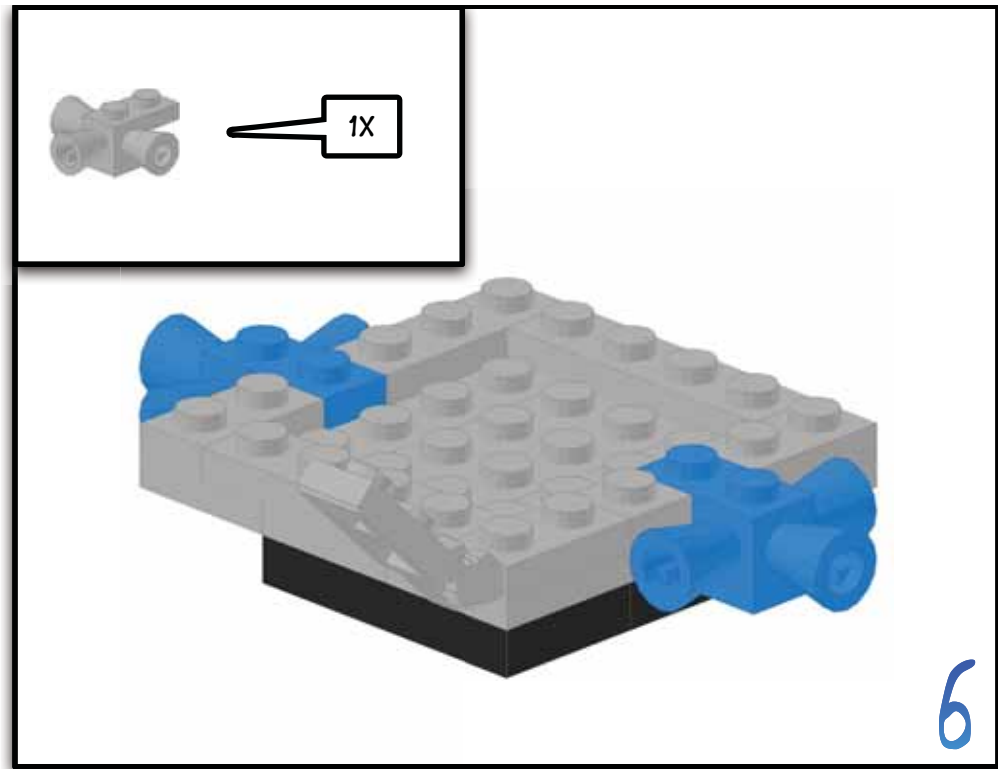
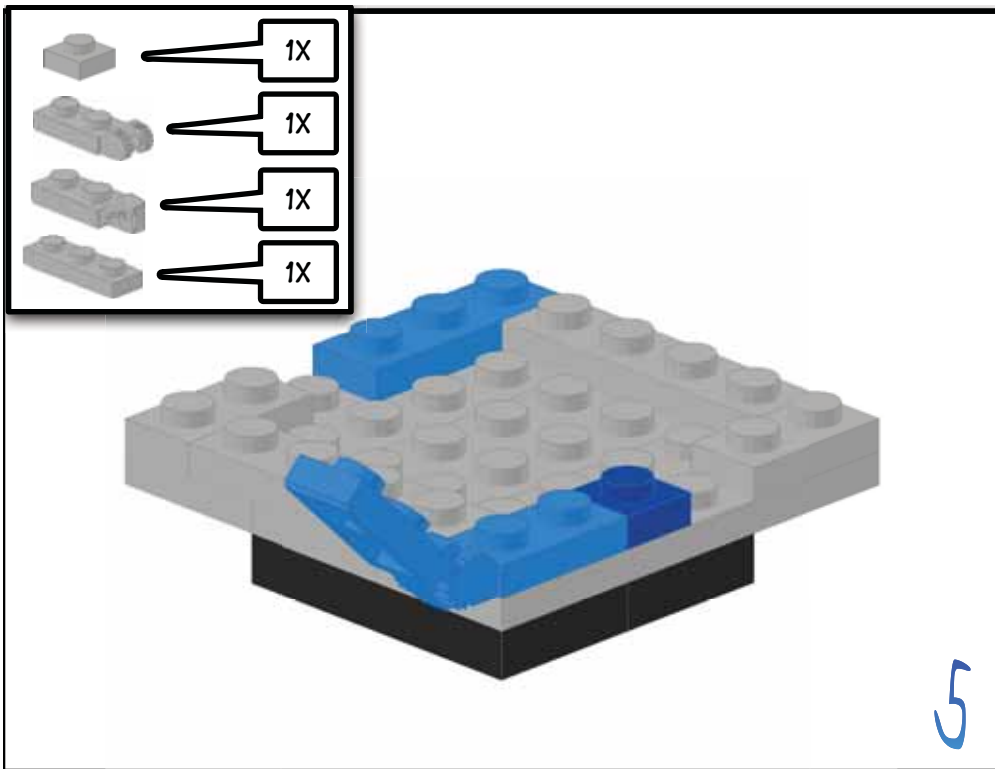

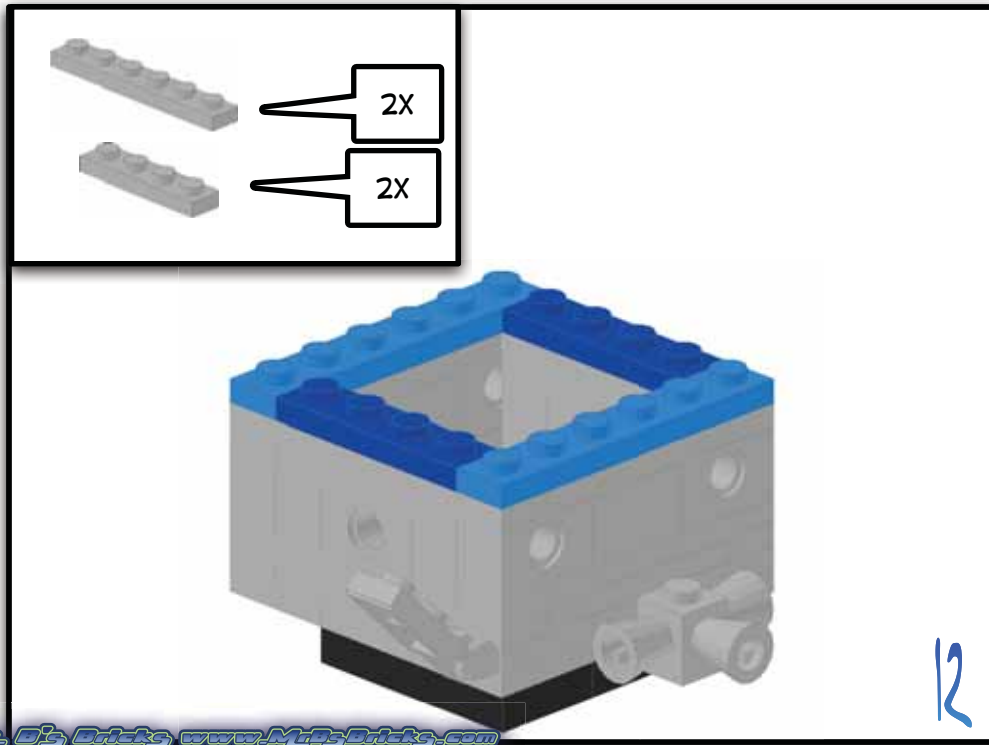
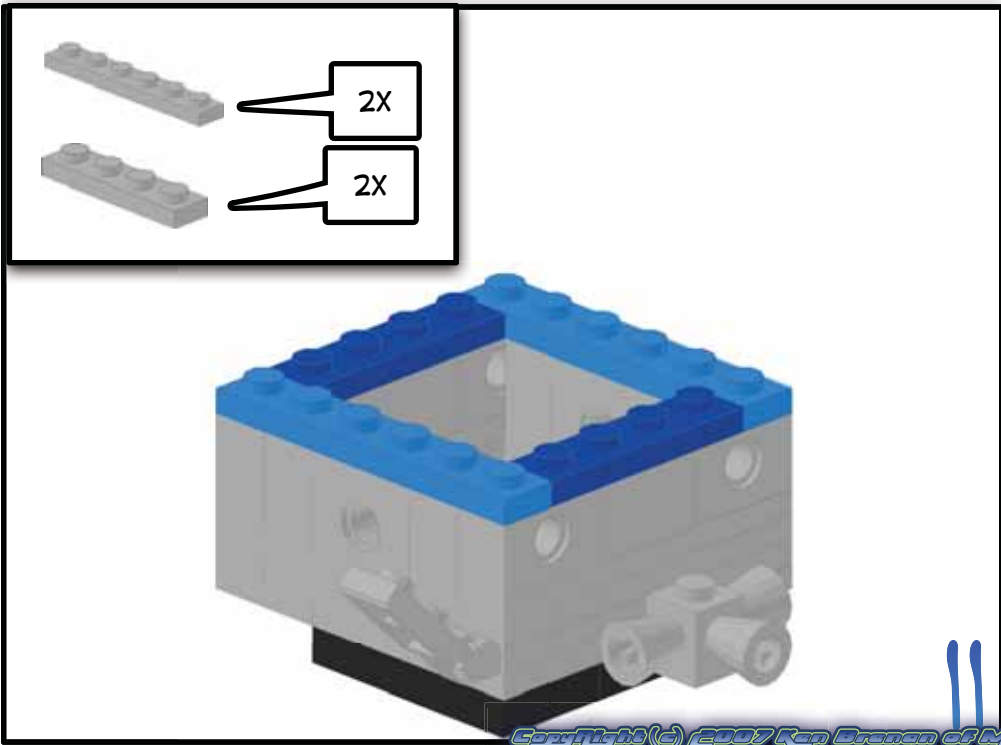
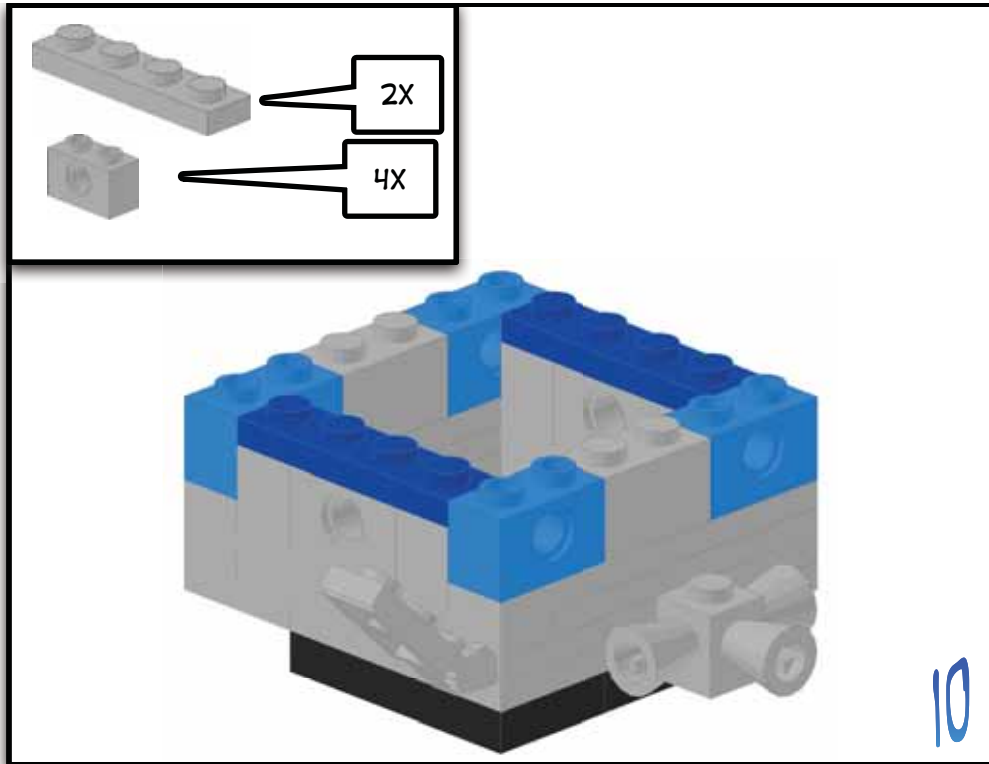
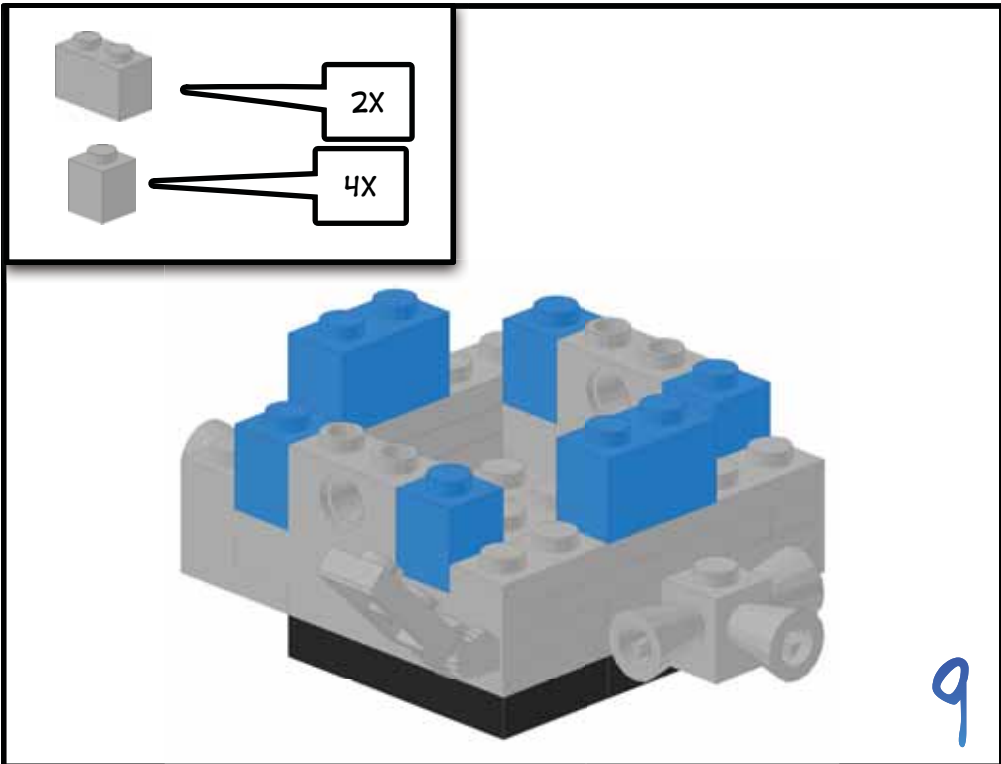

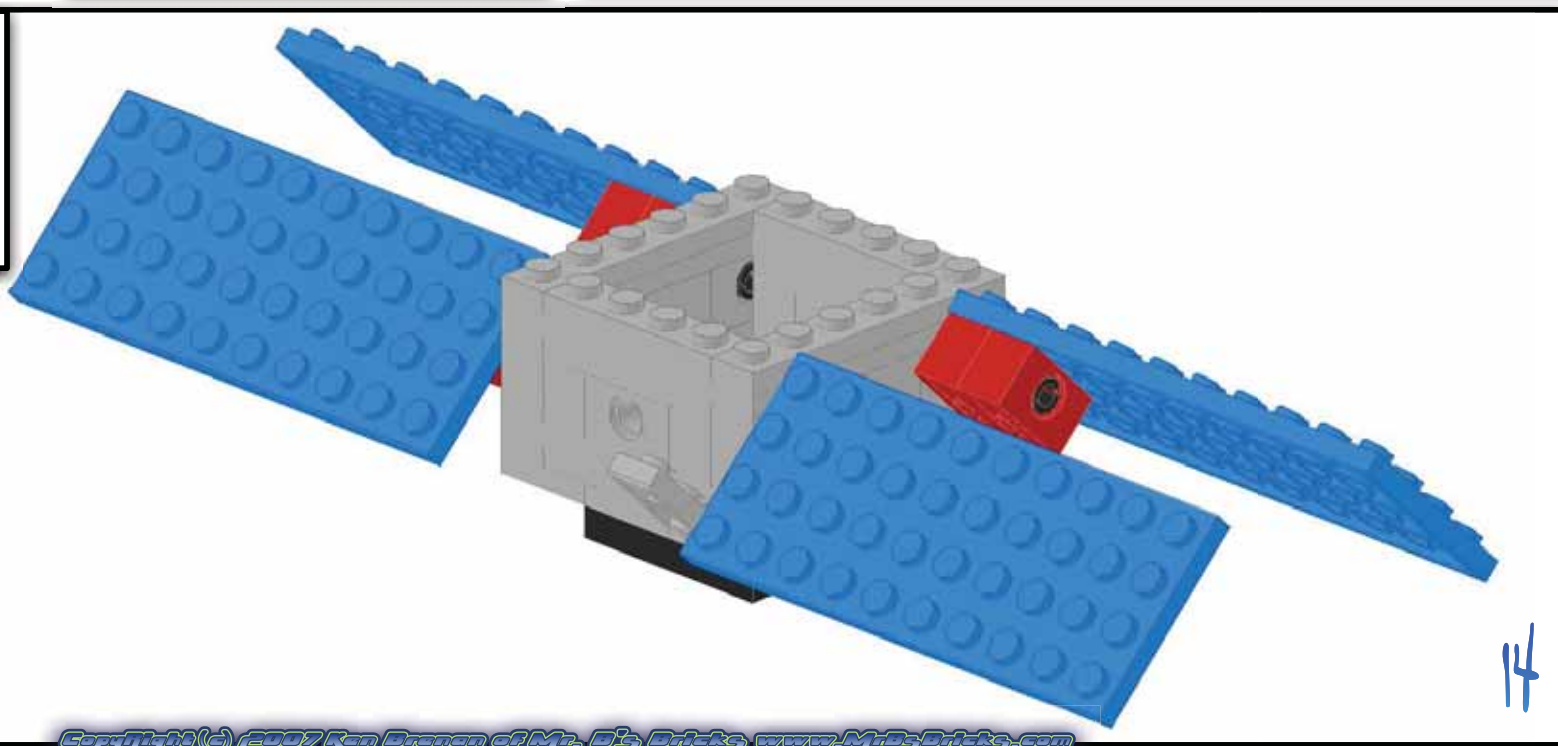
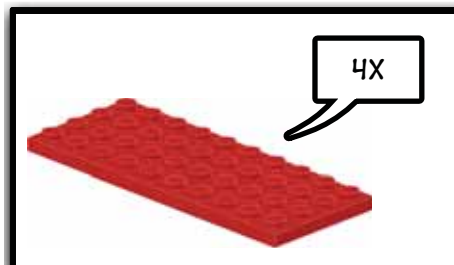
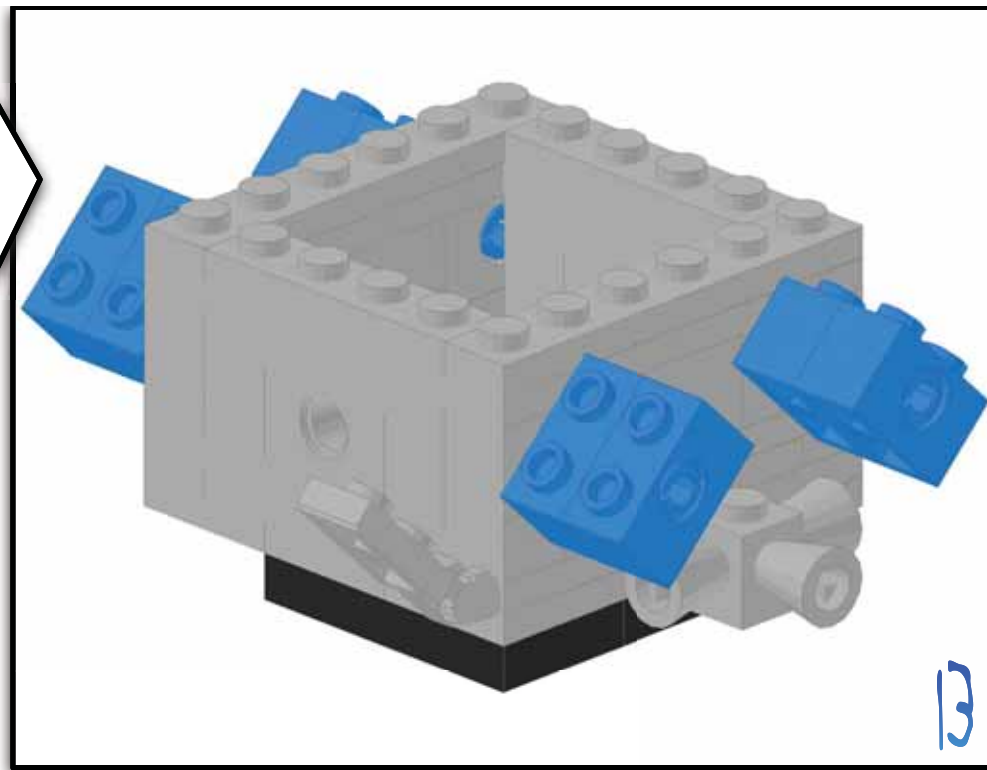
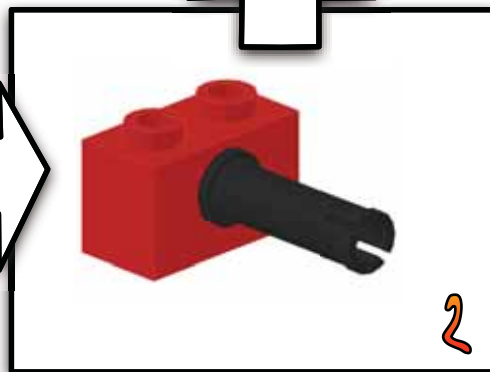
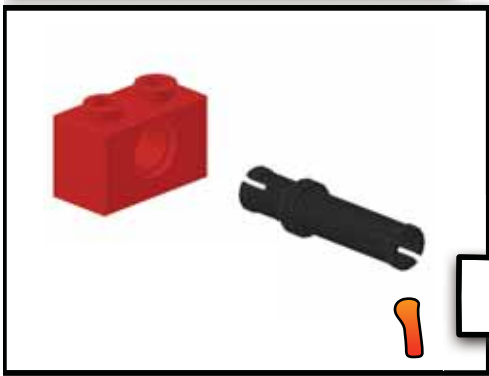
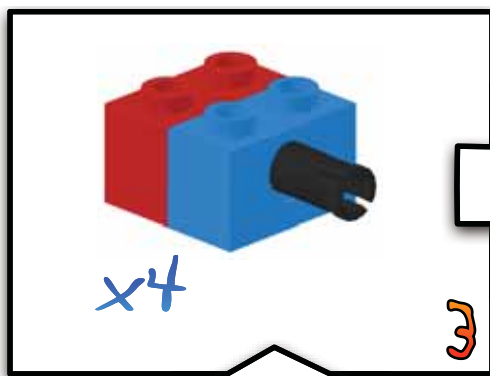
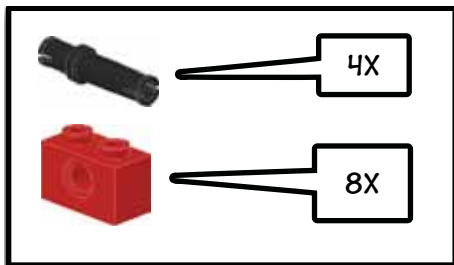

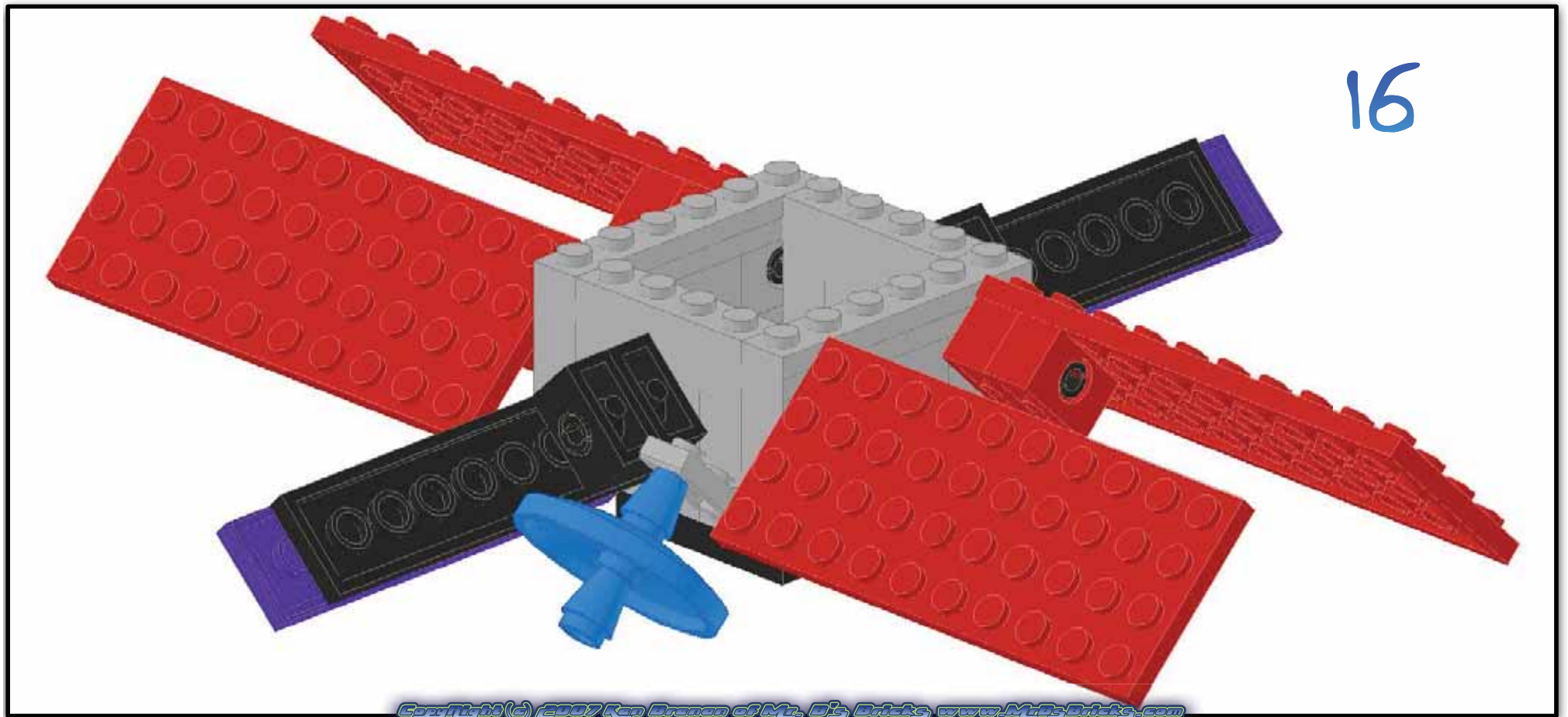
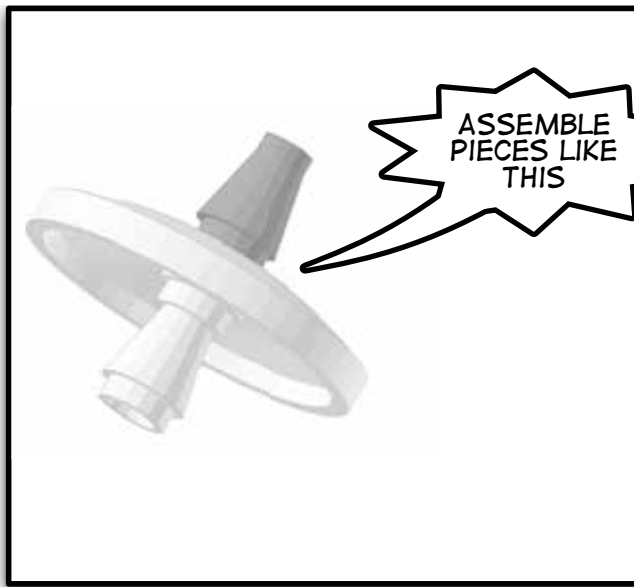
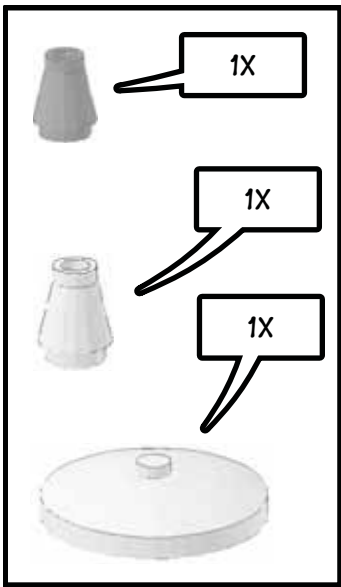



4X

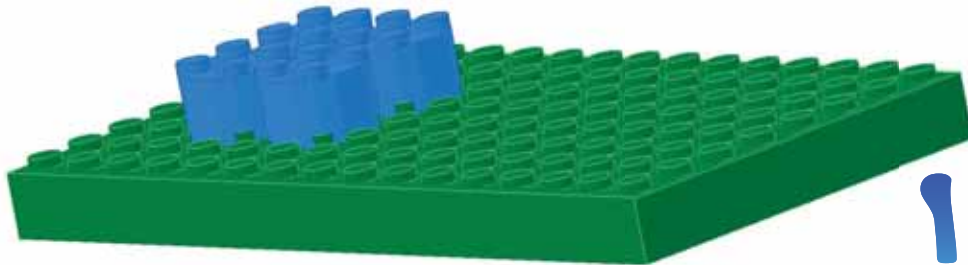
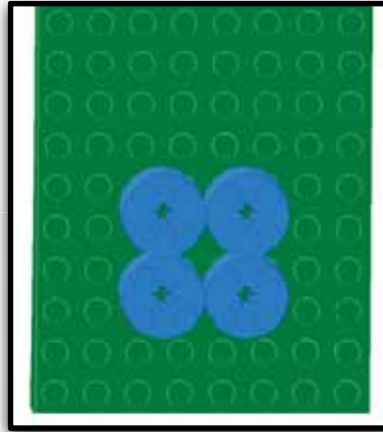

2X



2X

THIS PIECE MIGHT BE LIGHT GREY IN YOUR KIT

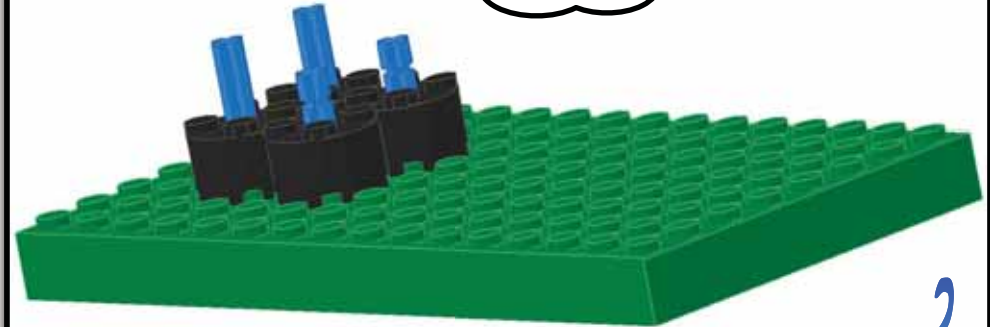

2X

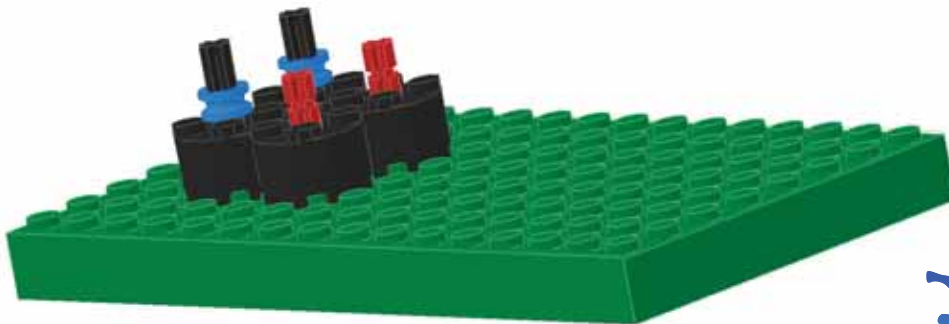

2X



1X



4X



1



2



3

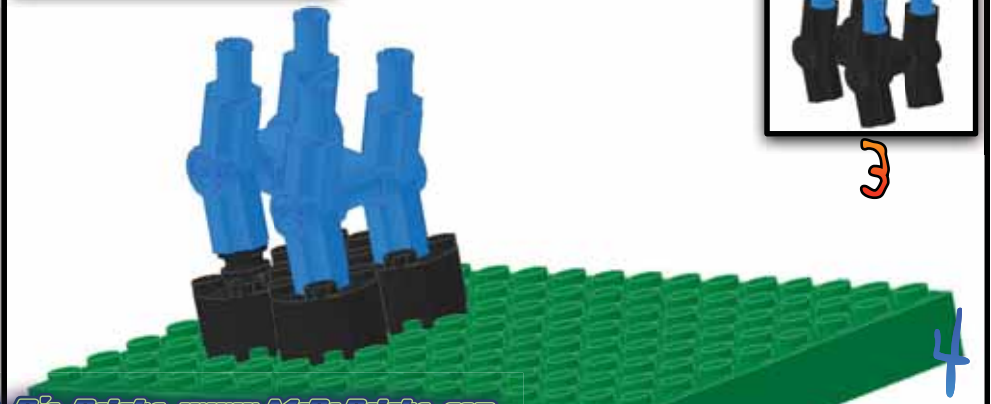

HINT: USE THE SHORTER
OF THE FOUR LEFT IN
THE KIT.

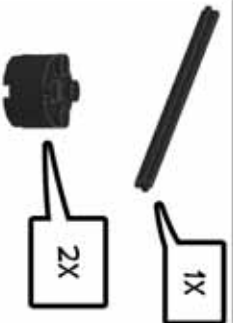

1

BOTH OF
THESE HAVE
HOLES

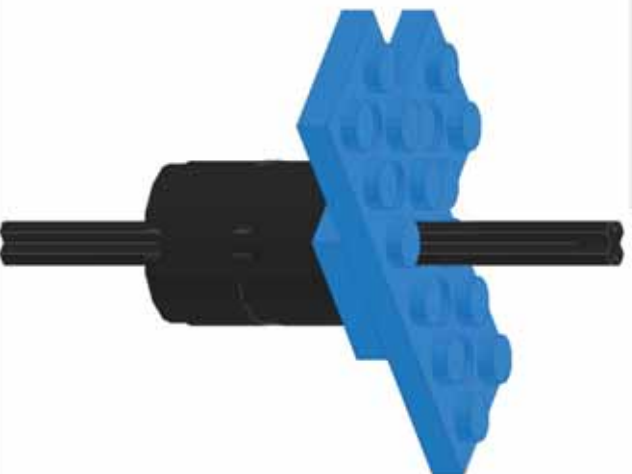

2

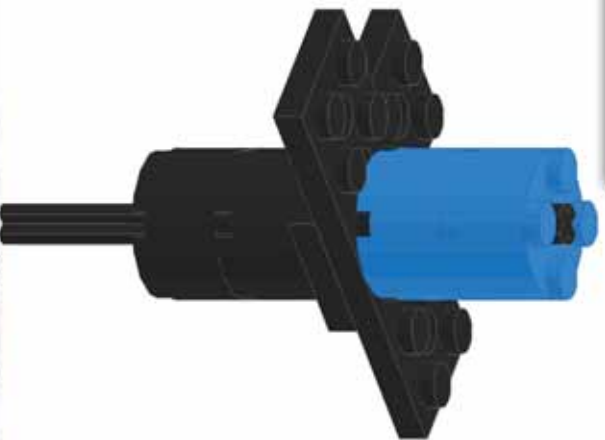

3

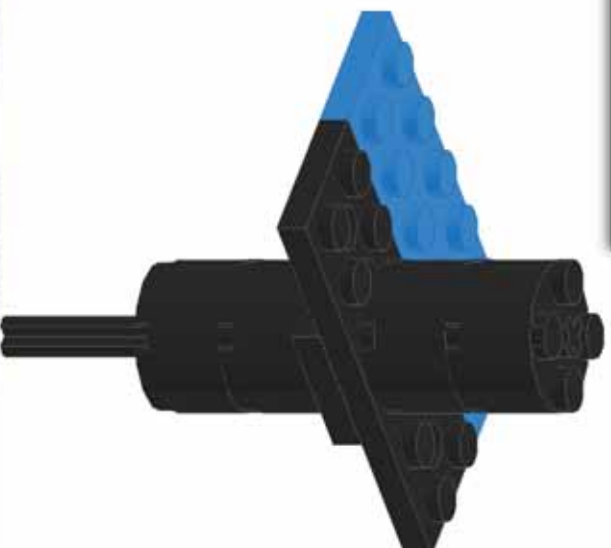

4

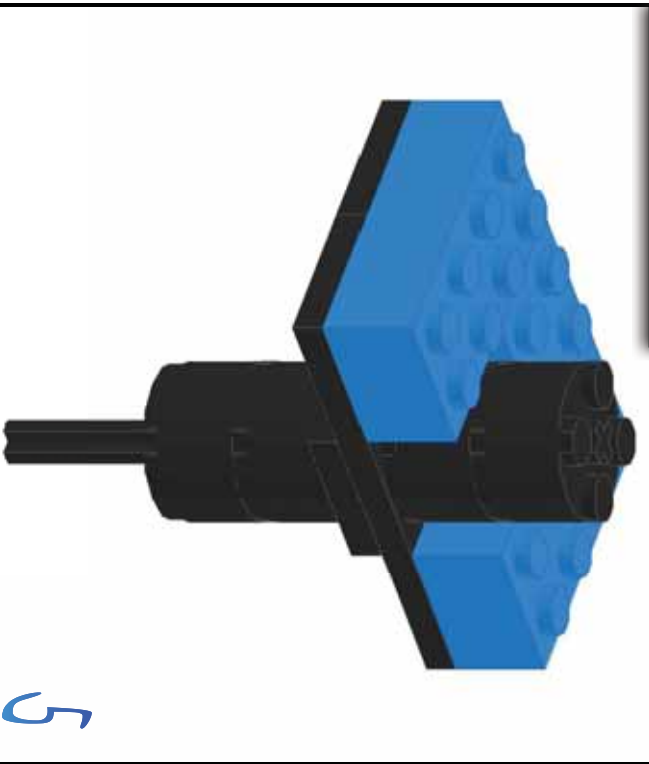
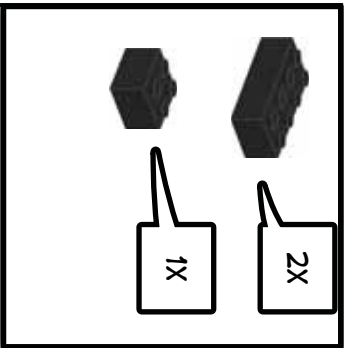

5

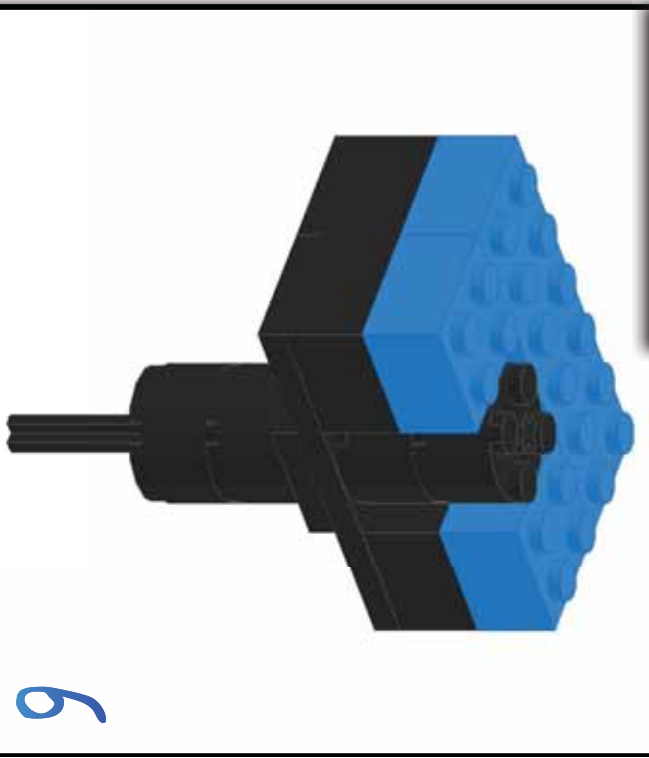
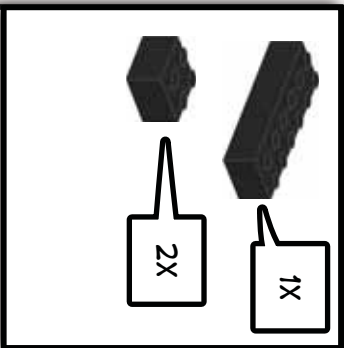

6

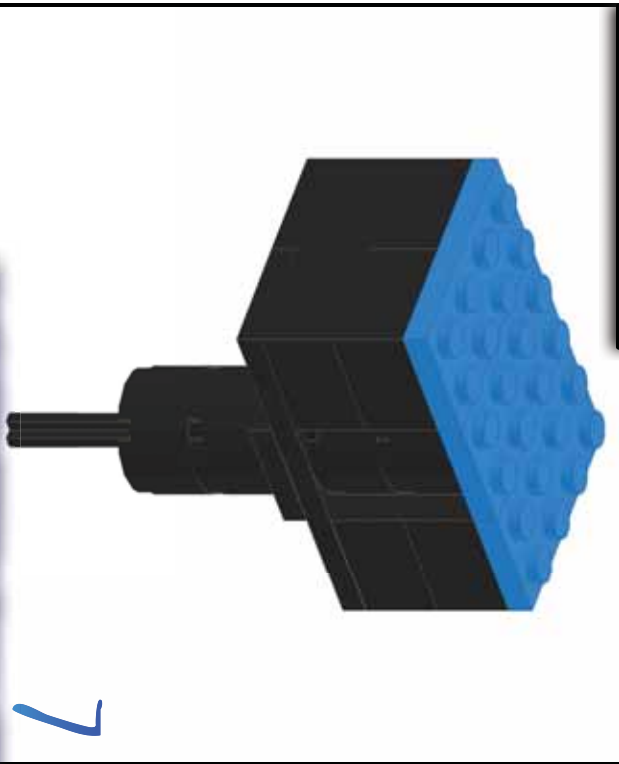
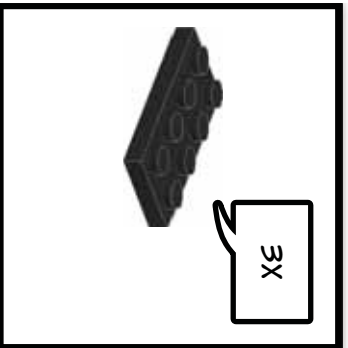

7

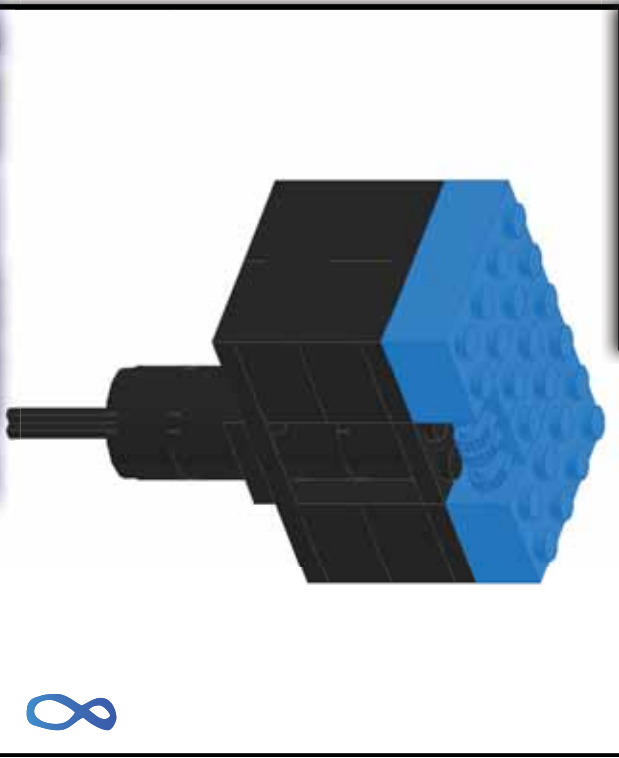
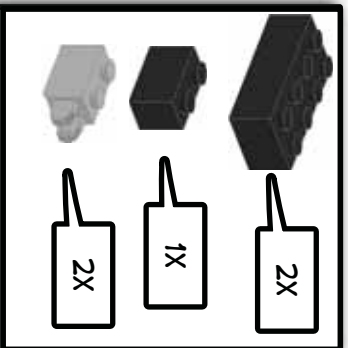

8

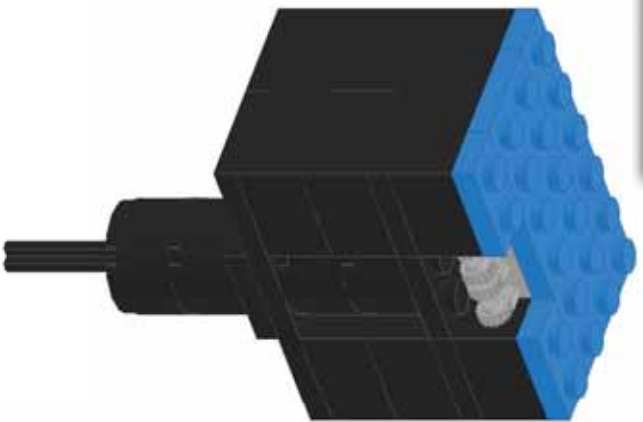
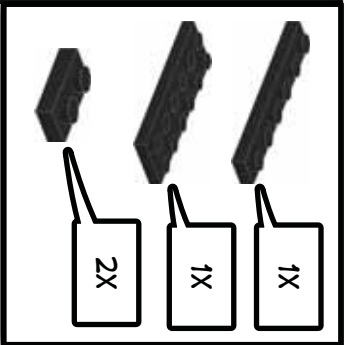

9

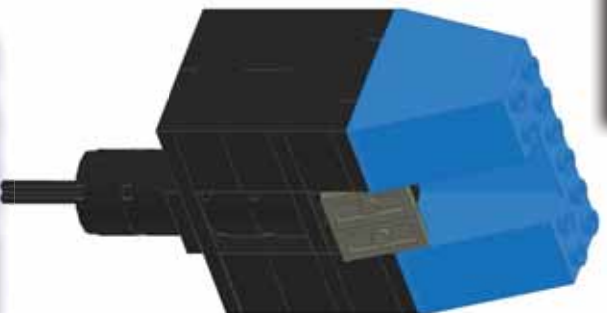
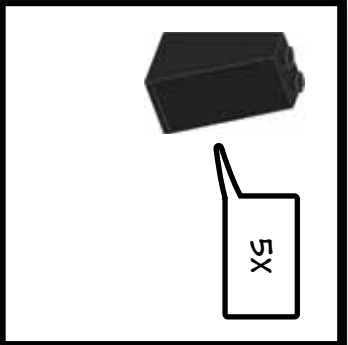

11

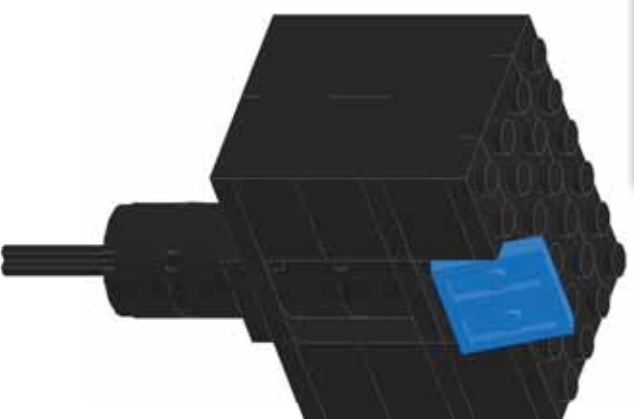
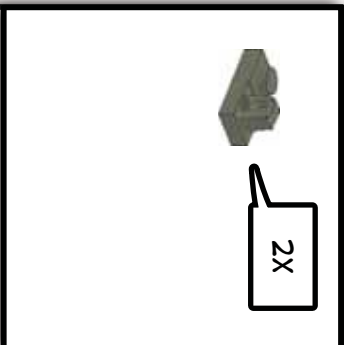

10

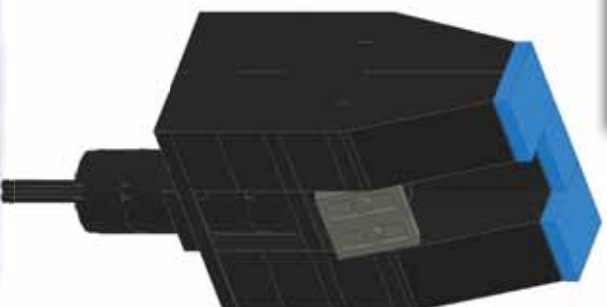
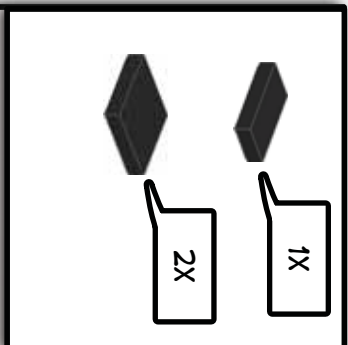

12

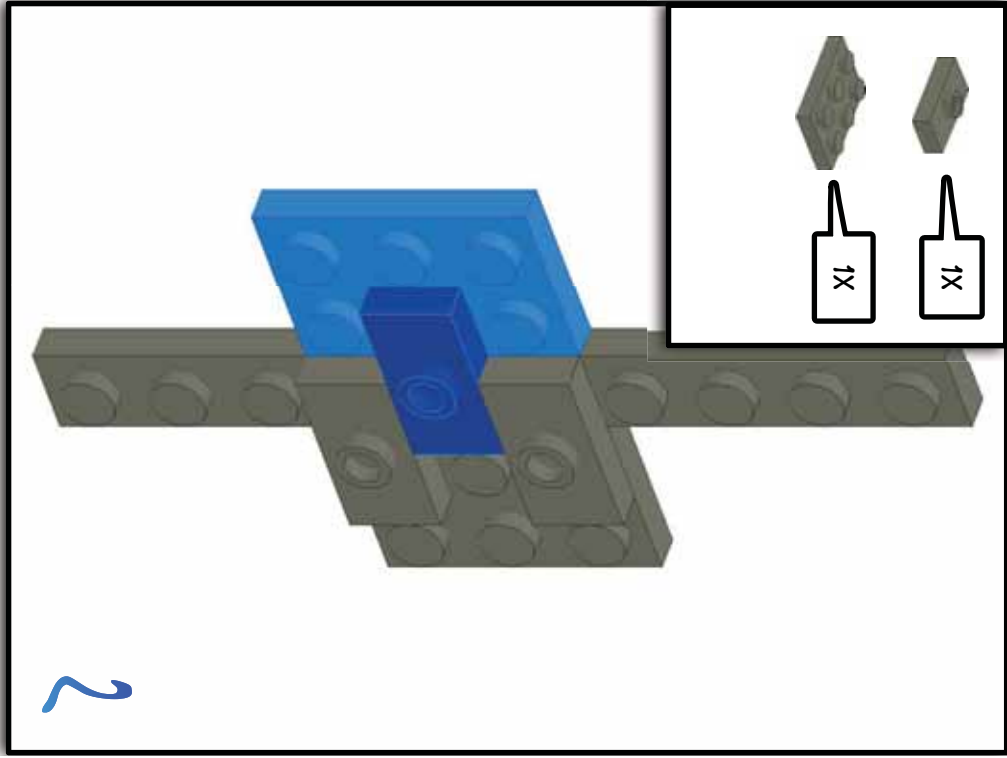
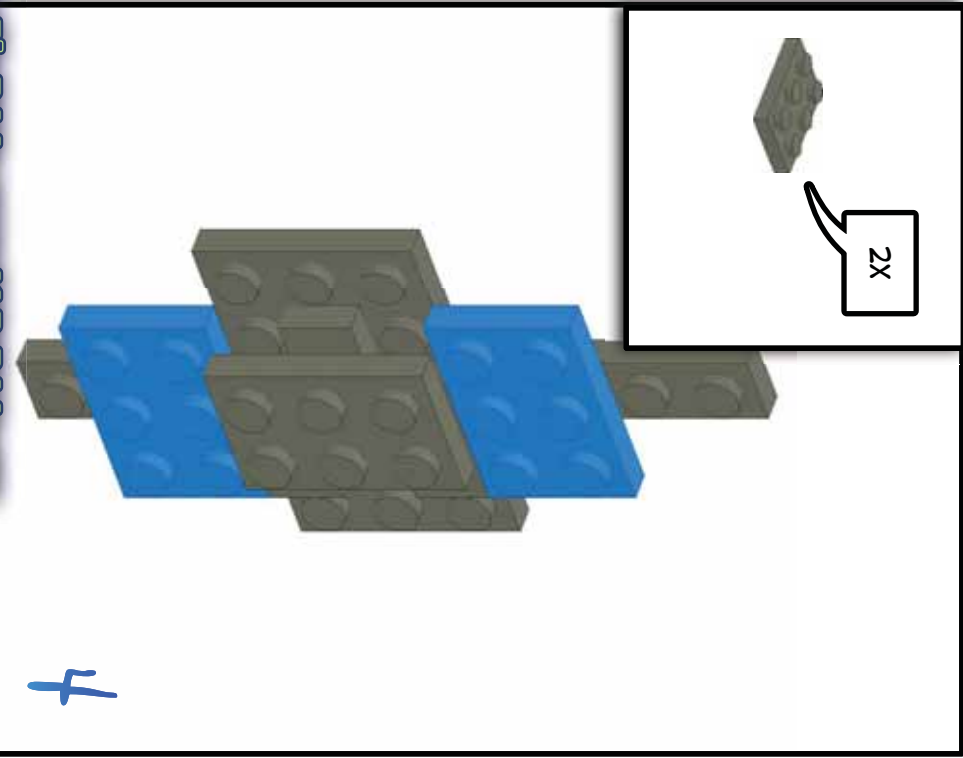
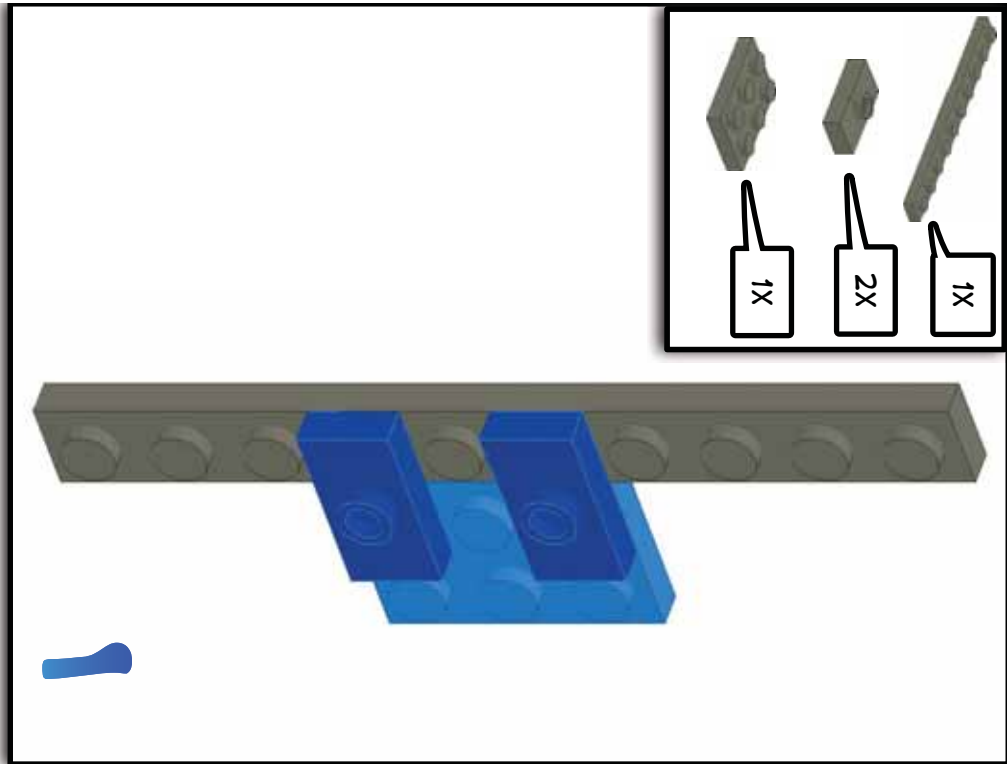
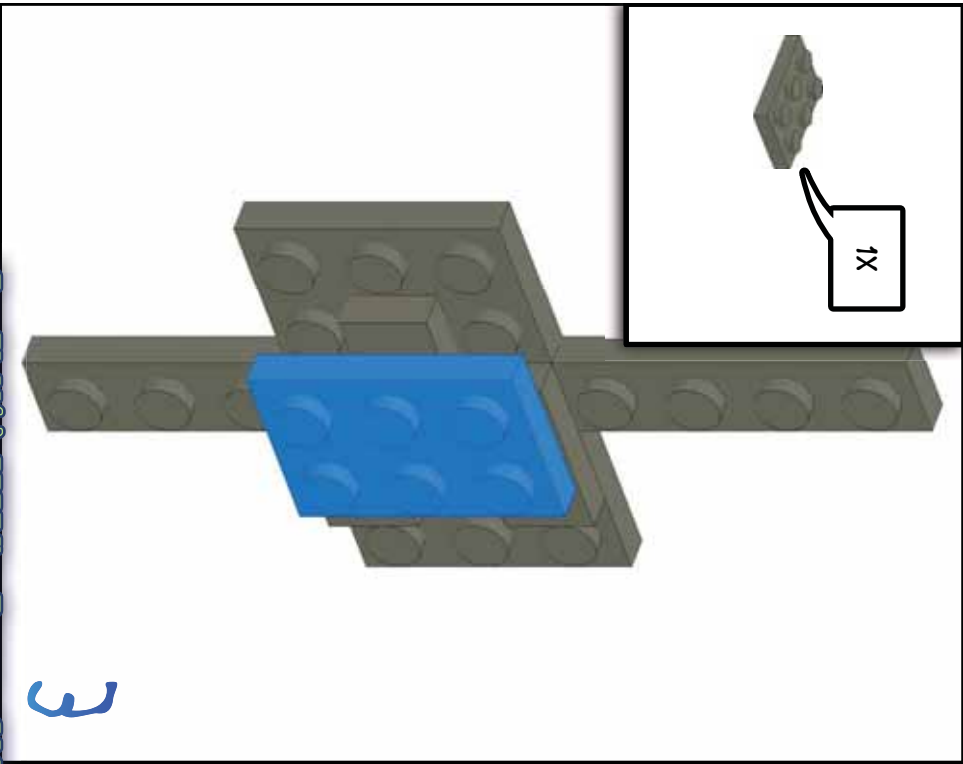

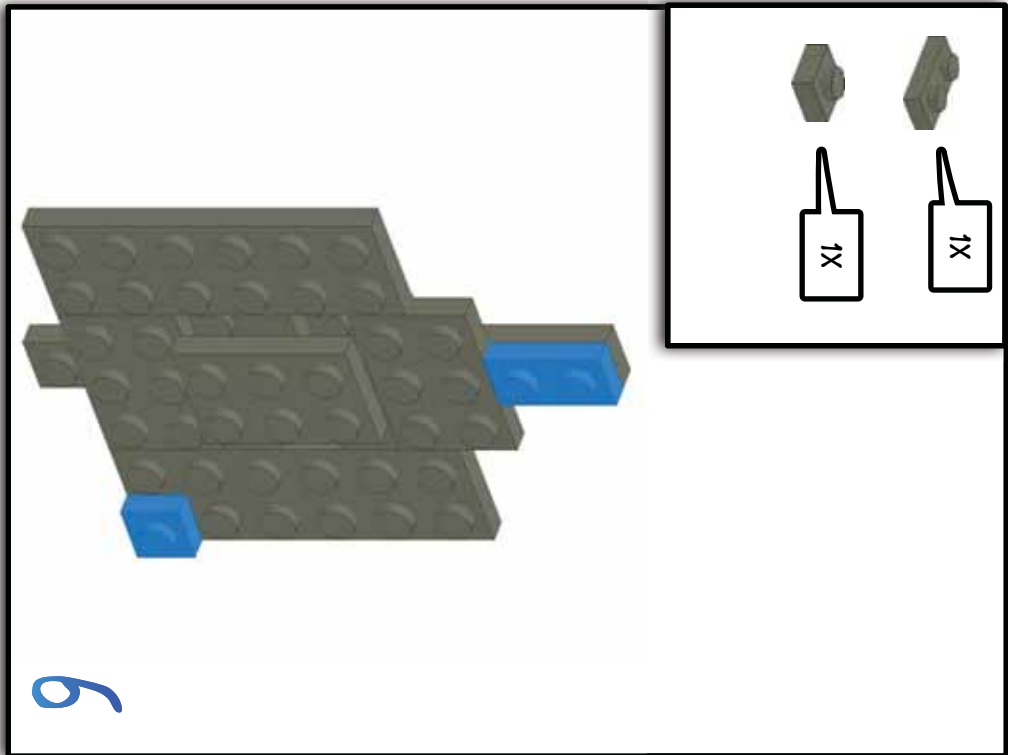
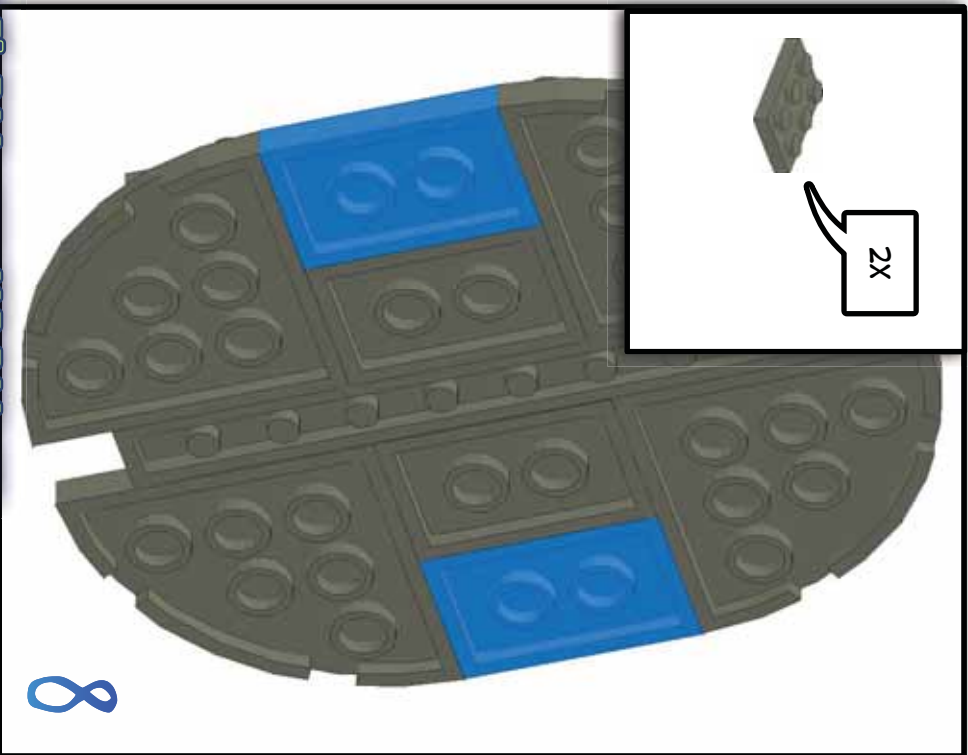
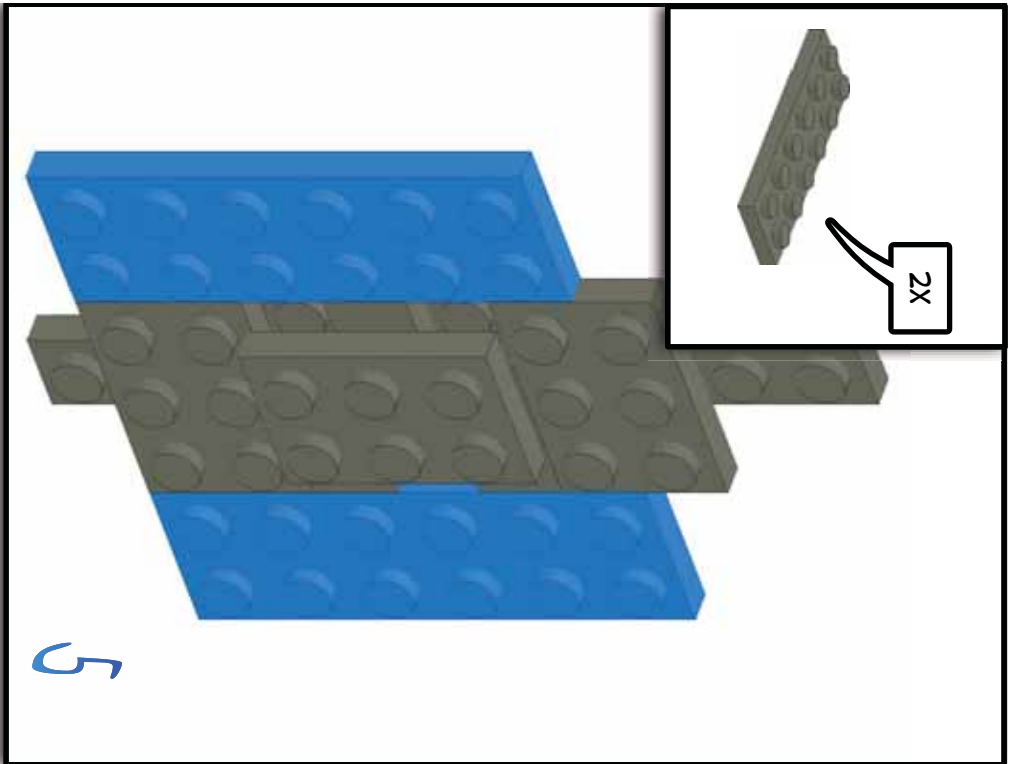
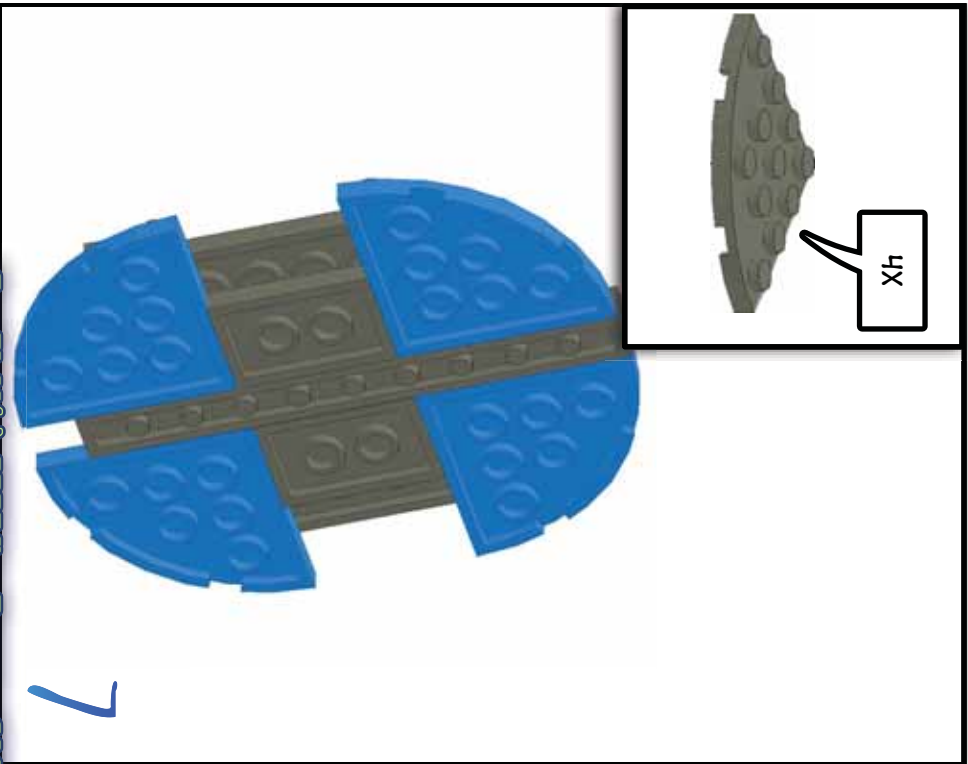

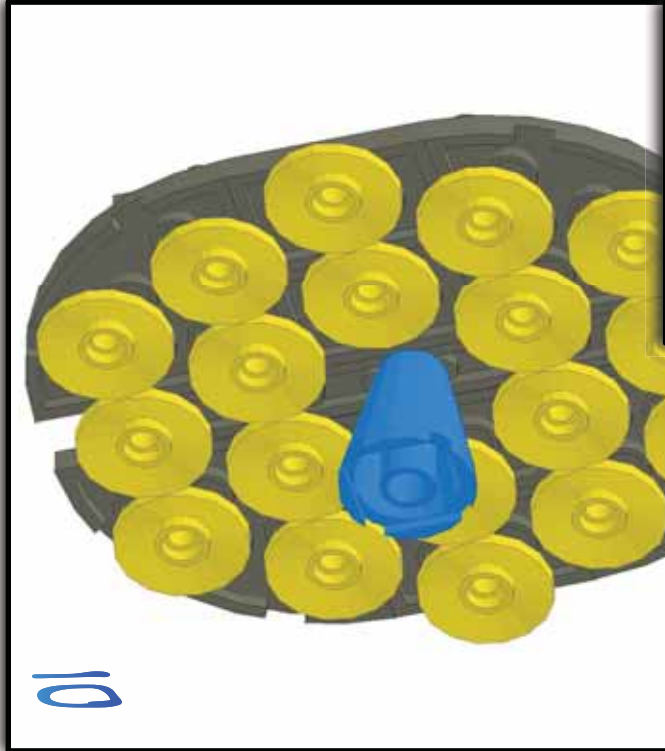
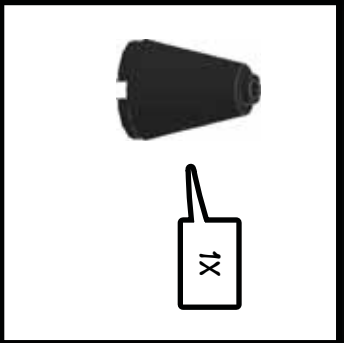
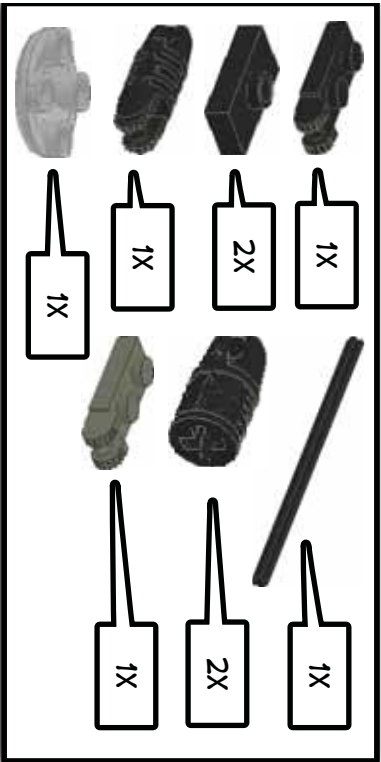
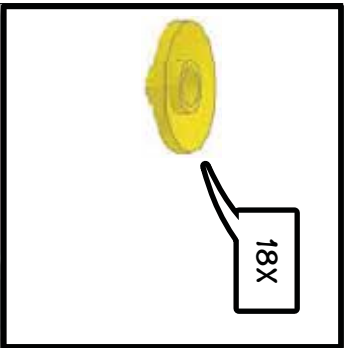

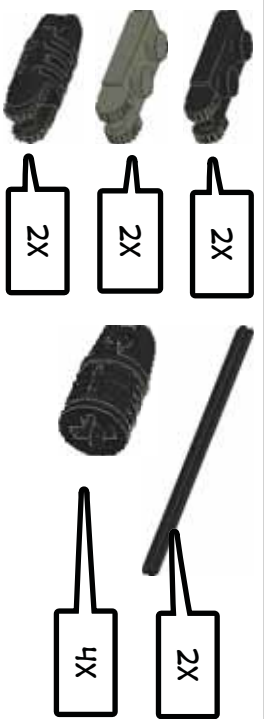

MAKE TWO OF THESE...

